

# 液晶模组说明书

## LCD Module Instructions

初定规格 Preliminary specification

正式规格 Official specifications

项目编号 Project No.	TFT-H043A2WQISTKN40_V0-4
产品描述 Product Description	TFT LCD Module 480 x 3RGB x 272 Dots 4.3 Inch TFT LCD

客户确认签章:

Signature by customer:

小批量试产 Trial production     大批量生产 Mass production

请返回一份带有您的签名和评论的确认副本

Please return one copy confirmation with signature and your comments

鑫洪泰科技（广东）有限公司

深圳市鑫洪泰电子科技有限公司

广东省东莞市凤岗镇东深公路凤岗段 208 号天安数码城 N3 栋 3 楼



正面 Front



背面 REAR

**一、基本特征 General Feature:**

项目 Item	标准值 Standard Value	单位 Unit
显示尺寸 Display Size	4.3	英寸 Inch
分辨率 Number of Pixels	480 (H) * 3 (RGB) * 272 (V)	点 dots
显示区域 Active Area	95.04 (H) * 53.86 (V)	毫米 mm
外形尺寸 Outline Dimension	105.42(H) * 67.07(V) * 3.00(D) <TFT>	毫米 mm
观看方向 Viewing Direction	全视角 FULL 0'clock	-
TFT 接口 TFT Interface	串行 8 位 RGB/并行 24 位 RGB Serial 8-bit RGB/Parallel 24-bit RGB	-
TFT 驱动芯片 TFT Driver IC	SC7283	-
TFT 驱动电压 TFT Driver Condition	VCI=3.3V(Typ)	伏 V
背光 Backlight	白色 LED/16 颗/4 颗串联 4 路并联 White LED/16 PCS/4 PCS serial 4 ways parallel	-
触摸屏 Touch Panel	<input checked="" type="checkbox"/> 不带触摸屏 <input type="checkbox"/> 带电阻触摸屏 <input type="checkbox"/> 带电容触摸屏 Without TP                      With RTP                      With CTP	-
电容触摸屏驱动芯片 CTP Driver IC	- - -	-
电容触摸屏驱动电压 CTP Driver Condition	- - -	伏 V
TFT 液晶工作温度 Operation Temperature	-30 ~ 80	摄氏度 ℃
TFT 液晶储存温度 Storage Temperature	-30 ~ 80	摄氏度 ℃

## 二、外形尺寸 Outline Dimensions

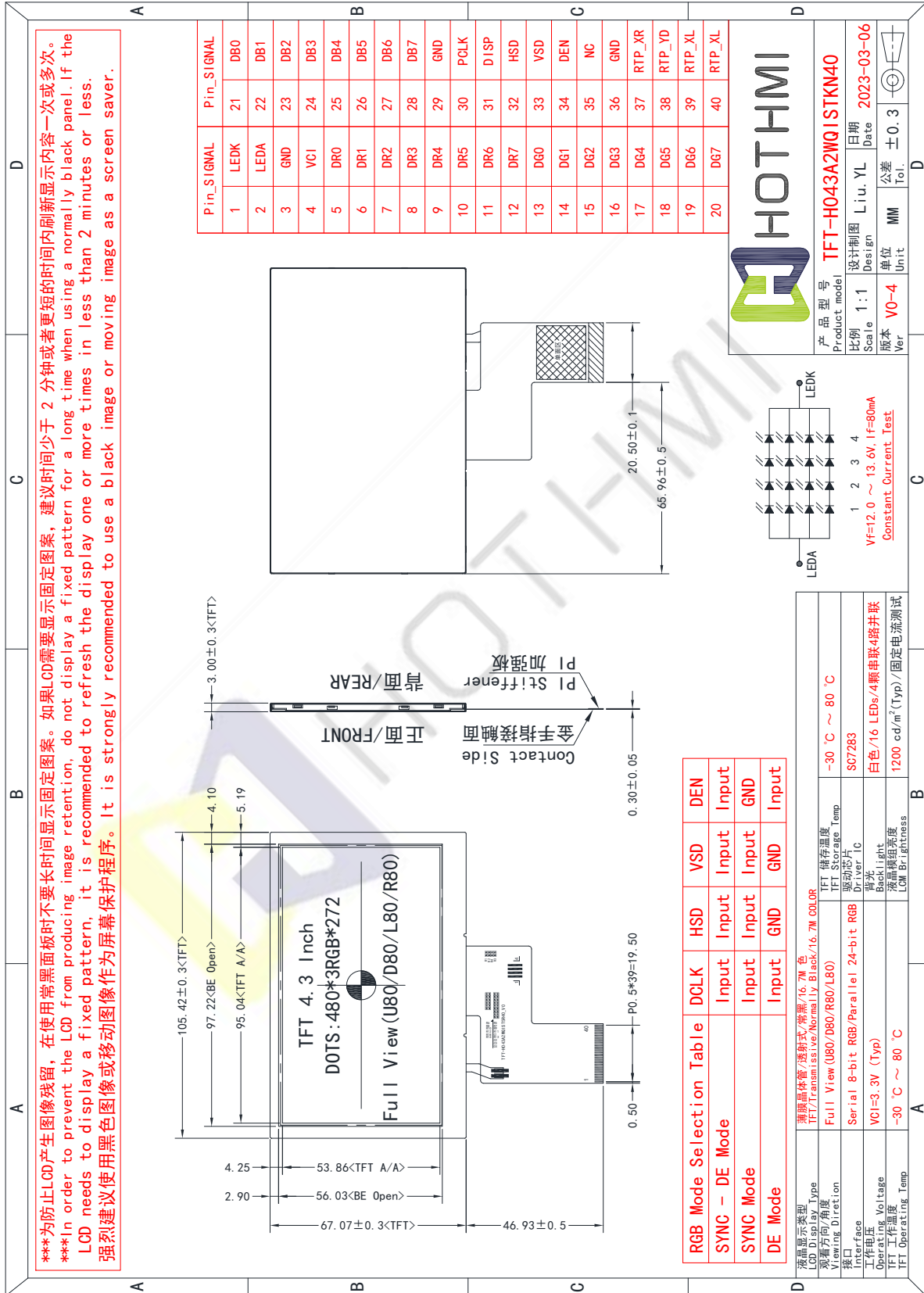

### 三、引脚说明 Pin Description

#### 3.1. 模组引脚说明 TFT Pin Description

引脚编号 Pin NO.	标号 Symbol	详细描述 Description
1	LEDK	LED阴极 LED cathode
2	LEDA	LED阳极 LED anode
3	GND	电源地 Power supply ground
4	VCI	电源 Power supply
5 ~ 12	DR0 ~ DR7	显示红色数据的8位数据总线, 在串行8位RGB接口中不使用, 应连接到 "GND"。 8 bit data bus display for red data, are not used in Serial 8-bit RGB interface and should be connected to "GND" .
13 ~ 20	DG0 ~ DG7	显示绿色数据的8位数据总线, 在串行8位RGB接口中使用。 8 bit data bus display for green data, Used in the serial 8-bit RGB interface.
21 ~ 38	DB0 ~ DB7	显示蓝色数据的8位数据总线, 在串行8位RGB接口中不使用, 应连接到 "GND"。 8 bit data bus display for blue data, are not used in Serial 8-bit RGB interface and should be connected to "GND" .
29	GND	电源地 Power supply ground
30	PCLK	像素时钟输入引脚 Pixel clock input pin
31	DISP	设定显示模式 (GND: 待命模式; VCI: 正常显示模式) set the display mode (GND: Standby mode; VCI: Normal display)
32	HSD	水平同步信号 Horizontal sync signal
33	VSD	垂直同步信号 Vertical sync signal
34	DEN	数据输入使能 Data input enable
- - - 下一页 - - - - - - Next page - - -		

引脚编号 Pin NO.	标号Symbol	详细描述 Description
35	NC	不连接 Not Connect
36	GND	电源地 Power supply ground
37	RTP_XR	RTP 控制引脚。不使用时，不连接这个引脚。 RTP control pin. When not in use, this pin is not connected.
38	RTP_YD	RTP 控制引脚。不使用时，不连接这个引脚。 RTP control pin. When not in use, this pin is not connected.
39	RTP_XL	RTP 控制引脚。不使用时，不连接这个引脚。 RTP control pin. When not in use, this pin is not connected.
40	RTP_YU	RTP 控制引脚。不使用时，不连接这个引脚。 RTP control pin. When not in use, this pin is not connected.
- - - 结束 - - - - - - END - - -		

### 3.2. 引脚连接说明 Pin Connection Description

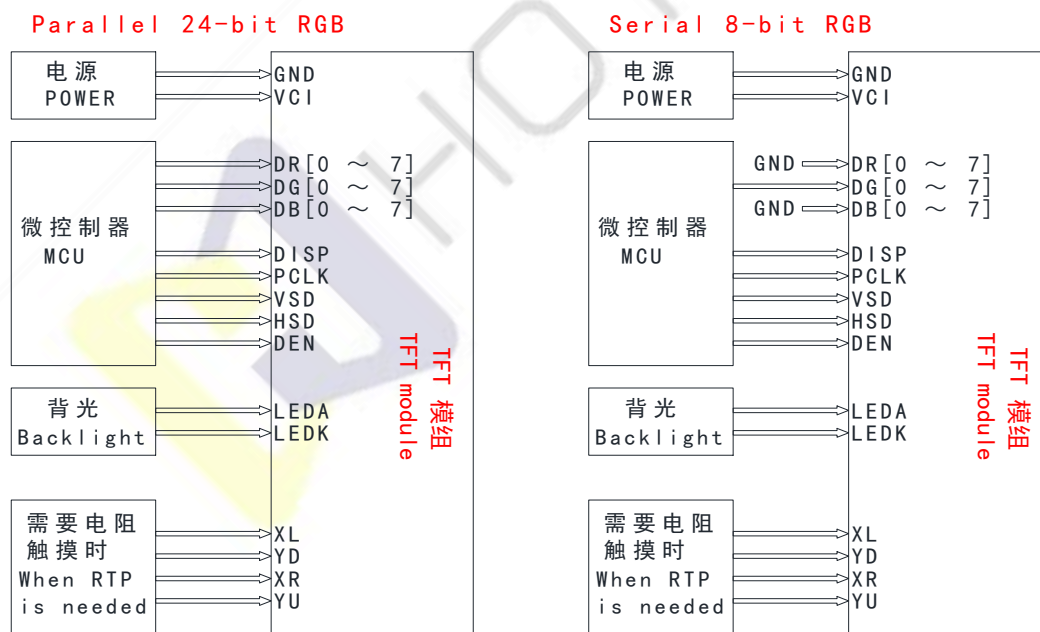

\*必须将电阻“R12”变更到“R11”  
 \*Resistor "R12" must be changed to "R11".

RGB Mode Selection Table	DCLK	HSD	VSD	DEN
SYNC - DE Mode	Input	Input	Input	Input
SYNC Mode	Input	Input	Input	GND
DE Mode	Input	GND	GND	Input



## 四、电气特性 Electrical Characteristics

### 4.1. 绝对最大额定值 Absolute Maximum Ratings

项目 Item	标号 Symbol	条件 Condition	最小值 Min	典型值 Type	最大值 Max	单位 Unit
数字电源 Digital Power	VCI	-	-0.3	-	4.0	伏 V
接口工作电压 IO Supply Voltage	IOVCC	-	-0.3	-	4.0	伏 V
输入电压范围 Input Voltage	VIN	-	-0.3	-	IOVCC +0.3	伏 V

注释 Note:

1. 超过上面列出的极限值可能会导致驱动 IC 永久损坏。这些值仅用于测试。IC 应在芯片特性条件下正常运行。如果不满足这些条件，IC 操作可能会出错，可靠性可能会下降。

That the exceeds the Limiting Value listed above it may cause the driver IC permanent damage. These values are for test only. IC should be operated under the Chip Characteristic conditions for normal operation. If these conditions are not met, IC operation may be error and the reliability may be deteriorated.

2. 参数在工作温度范围内有效，除非另有说明。除非另有说明，所有电压均相对于 GND。

Parameters are valid over operating temperature range unless otherwise specified. All voltages are with respect to GND unless otherwise noted.

3. 确保 IOVCC、VCI 的电压电平始终符合正确的关系： $3.1V \leq IOVCC \leq VCI \leq 3.6V$ 。

Insure the voltage levels of IOVCC, VCI, always matches the correct relation:  $3.1V \leq IOVCC \leq VCI \leq 3.6V$ .

4. VIN 应小于或等于 3.6V。 ( $VIN \leq 3.6V$ )。

VIN should be less than or equal to 3.6V. ( $VIN \leq 3.6V$ ).

5. 面板显示质量取决于面板负载，在低温/高温下可能有不同的性能。

Panel display quality depends on panel loading, and it may have the different performance at low/high temperature.

#### 4.2. TFT 模组工作条件 TFT LCD Module Operating Conditions

项目 Item	标号 Symbol	条件 Condition	最小值 Min	典型值 Type	最大值 Max	单位 Unit
数字电源 Digital Power	VCI	-	3.1	3.3	3.6	伏 V
接口工作电压 IO Supply Voltage	IOVCC	-	3.1	3.3	3.6	伏 V
输入电压 Input Voltage	Vih		0.8* IOVCC	-	IOVCC	伏 V
	Vil		GND	-	0.3* IOVCC	
待机电流 Standby Current	Isc	No Load@ FR=60Hz	-	-	-	微安 uA
工作电流 Operation Current	Ioc		-	-	-	毫安 mA

#### 4.3. CTP 工作条件 (需要时) CTP Operating Conditions (When needed)

项目 Item	标号 Symbol	条件 Condition	最小值 Min	典型值 Type	最大值 Max	单位 Unit
数字电源 Digital Power	VDD	-	2.8	-	3.3	伏 V
接口工作电压 IO Supply Voltage	IOVDD	-	1.8	-	3.3	伏 V
透光率 Transmittance	-	-	80	-	-	百分比 %
表面硬度 Surface hardness	-	划线 Scribing	-	3H	-	
TFT 液晶工作温度 Operation Temperature	OT	≤90%RH	-20	-	70	摄氏度 ℃
TFT 液晶储存温度 Storage Temperature	ST		-30	-	80	摄氏度 ℃

注释:

- 1、表面硬度按铅笔硬度标准

Notes:

- 1、The surface hardness is according to the pencil hardness standard



#### 4.4. 背光工作条件 LED back light specification

##### 1) 、单芯灯背光 Single core lamp backlight

项目 Item	标号 Symbol	条件 Condition	最小值 Min	典型值 Type	最大值 Max	单位 Unit
工作电压 Forward voltage	VF	If=3.2V/20mA /1-chip	12.0	12.8	13.6	伏 V
工作电流 Forward current	IF		-	80	-	毫安 mA
亮度 (带 LCD) Luminance (With LCD)	Lv	不带触摸 Without TP	-	1200	-	坎德拉/平方米 cd/m <sup>2</sup>
		带触摸 With TP	-	-	-	
LED 寿命 LED life time	Hr	Ta=25±3 °C	20,000	30,000	-	小时 Hour

注释 Note:

1. LED 寿命 (Hr) 定义为在 Ta=25±3 °C, 上表所示的典型电压电流值条件下持续工作直至亮度低于 50% 的时间。

LED life time (Hr) can be defined as the time in which it continues to operate under the condition: Ta=25±3 °C, typical IL value indicated in the above table until the brightness becomes less than 50%.

2. 以上结果是按MTBF计算方式预估判定的LED失效时间, 实际测试LED在Ta=25±3 °C点亮5000H, 亮度衰减 8%.

The above results are estimated and judged by the MTBF calculation method of the LED failure time. The actual test LED is lit for 5000H at Ta=25±3 °C, and the brightness decays by 8%.

## 五、液晶光学规格 TFT OPTICAL SPECIFICATION

### 5.1 概述 Overview

光学规格的测试应在暗室（环境亮度 1lux，温度=25 ℃）中使用亮度计系统（测角仪系统和TOPCON BM-5）设备进行测量，测试单元应位于大约在  $\theta$  和  $\Phi$  等于 0 的视角下，距 LCD 表面 50cm 的距离。显示面上测量点的中心应保持固定。测量前背光应工作 30 分钟。

The test of Optical specifications shall be measured in a dark room (ambient luminance 1lux and temperature = 25 ℃) with the equipment of Luminance meter system (Goniometer system and TOPCON BM-5) and test unit shall be located at an approximate distance 50cm from the LCD surface at a viewing angle of  $\theta$  and  $\Phi$  equal to 0 . The center of the measuring spot on the Display surface shall stay fixed. The backlight should be operating for 30 minutes prior to measurement.

### 5.2 光学规格 Optical Specifications

参数 Parameter		标号 Symbol	条件 Condition	最小值 Min.	典型值 Typ.	最大值 Max.	单位 Unit	备注 Remark
视角范围 Viewing Angle Range	水平 Horizontal	⊙左/L	CR>10	-	80	-	Deg.	Note 1
		⊙右/R		-	80	-	Deg.	
	垂直 Vertical	⊙上/U		-	80	-	Deg.	
		⊙下/D		-	80	-	Deg.	
对比度 Contrast ratio		CR	⊙ = 0°	-	800	-	-	Note2
色域 Color Gamut		CG	CIE1931	-	50	-	%	
白色色度 White Chromaticity		Wx	⊙ = 0°	-0.03	0.320	+0.03	-	Note4 (Based on C Light)
		Wy			0.345		-	
色彩还原 Reproduction of color	红 Red	Rx			0.629		-	
		Ry			0.326		-	
	绿 Green	Gx			0.337		-	
		Gy			0.546		-	
	蓝 Blue	Bx			0.136		-	
		By			0.143		-	
响应时间（上升 + 下降） Response Time (Rising + Falling)		Tr+Tf	⊙ = 0° Ta= 25℃	-	30	40	ms	Note5

注释 Note:

1. 视角是对比度大于10的角度。视角确定为相对于光轴的水平或3、9点钟方向和垂直或6、12点钟方向 垂直于 LCD 表面（见图 1）。

Viewing angle is the angle at which the contrast ratio is greater than 10. The viewing angles are determined for the horizontal or 3, 9 o' clock direction and the vertical or 6, 12 o' clock direction with respect to the optical axis which is normal to the LCD surface (see FIGURE 1).

2. 对比度测量应在  $\theta = 0$  的视角和 LCD 表面的中心进行。亮度测量时，视场中的所有像素首先设置为白色，然后设置为暗（黑色）状态。（参见图 1）亮度对比度（CR）是通过数学定义的。

Contrast measurements shall be made at viewing angle of  $\Theta = 0$  and at the center of the LCD surface. Luminance shall be measured with all pixels in the view field set first to white, then to the dark (black) state . (see FIGUR 1) Luminance Contrast Ratio (CR) is defined mathematically.

$$CR = \frac{\text{Luminance when displaying a white raster}}{\text{Luminance when displaying a black raster}}$$

3. 透射率是没有 APF 和没有 CG 的值。

Transmittance is the Value without APF and without CG.

4. 上表中规定的色度坐标应由所有像素首先测量的光谱数据计算为红色、绿色、蓝色和白色。测量应在面板的中心进行。

The color chromaticity coordinates specified in the above table shall be calculated from the spectral data measured with all pixels first in red, green, blue and white. Measurements shall be made at the center of the panel.

5. 电光响应时间测量应如图 2 所示，通过打开和关闭“数据”输入信号来进行。亮度从 10%变化到90%所需的时间是 $T_r$ ，90%到10%是 $T_f$ 。

The electro-optical response time measurements shall be made as FIGURE 2 by switching the “data” input signal ON and OFF. The times needed for the luminance to change from 10% to 90% is  $T_r$ , and 90% to 10% is  $T_f$ .

Figure1 Measurement Set Up



图 1



图 2

## 六、时序 Timing

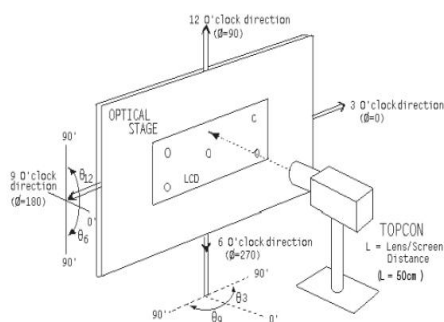
### 6.1. 同步模式 SYNC Mode

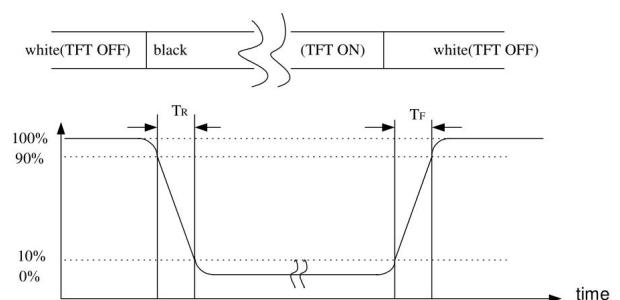
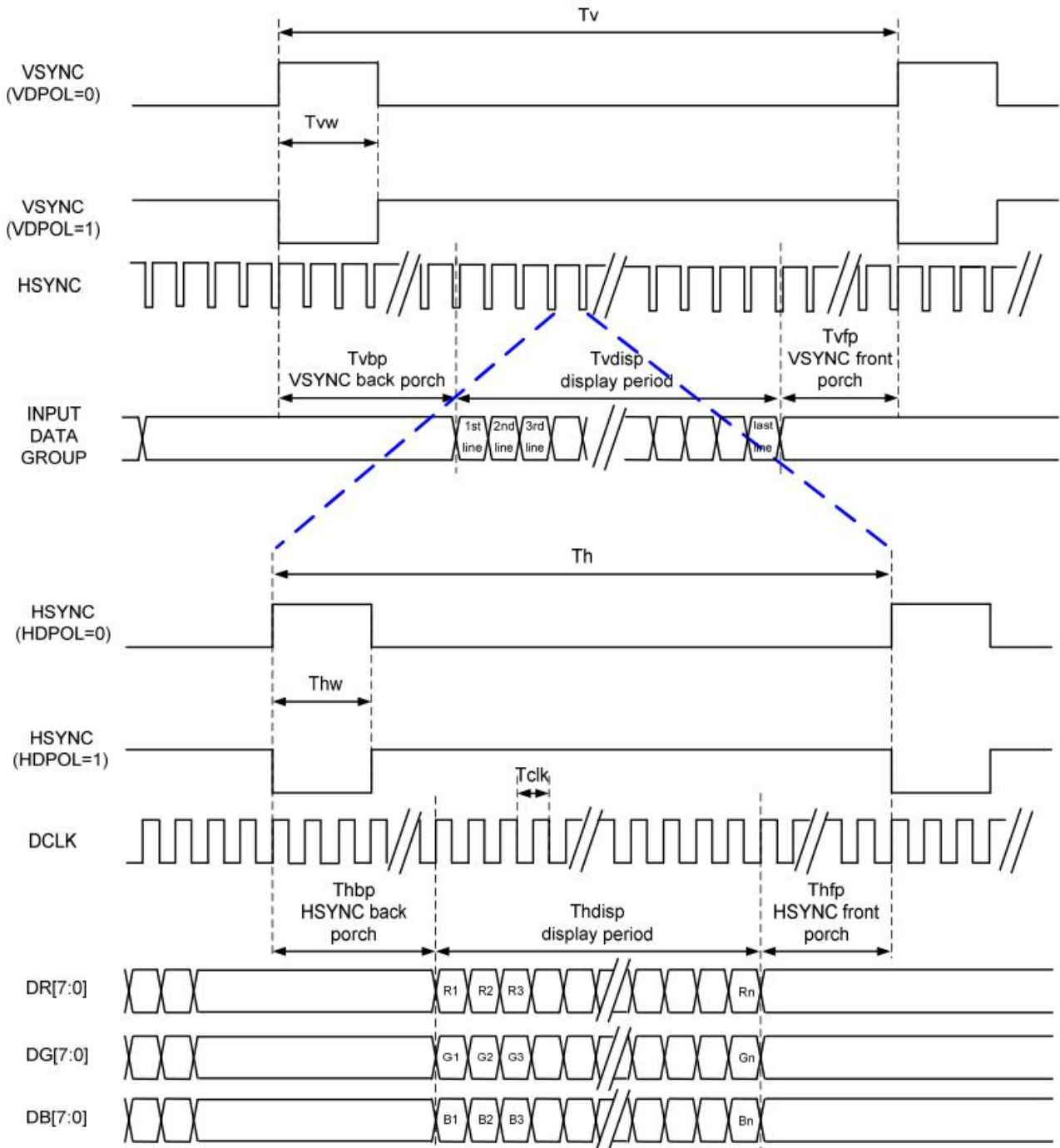

## 6. 2. DE 同步模式 SYNC-DE Mode

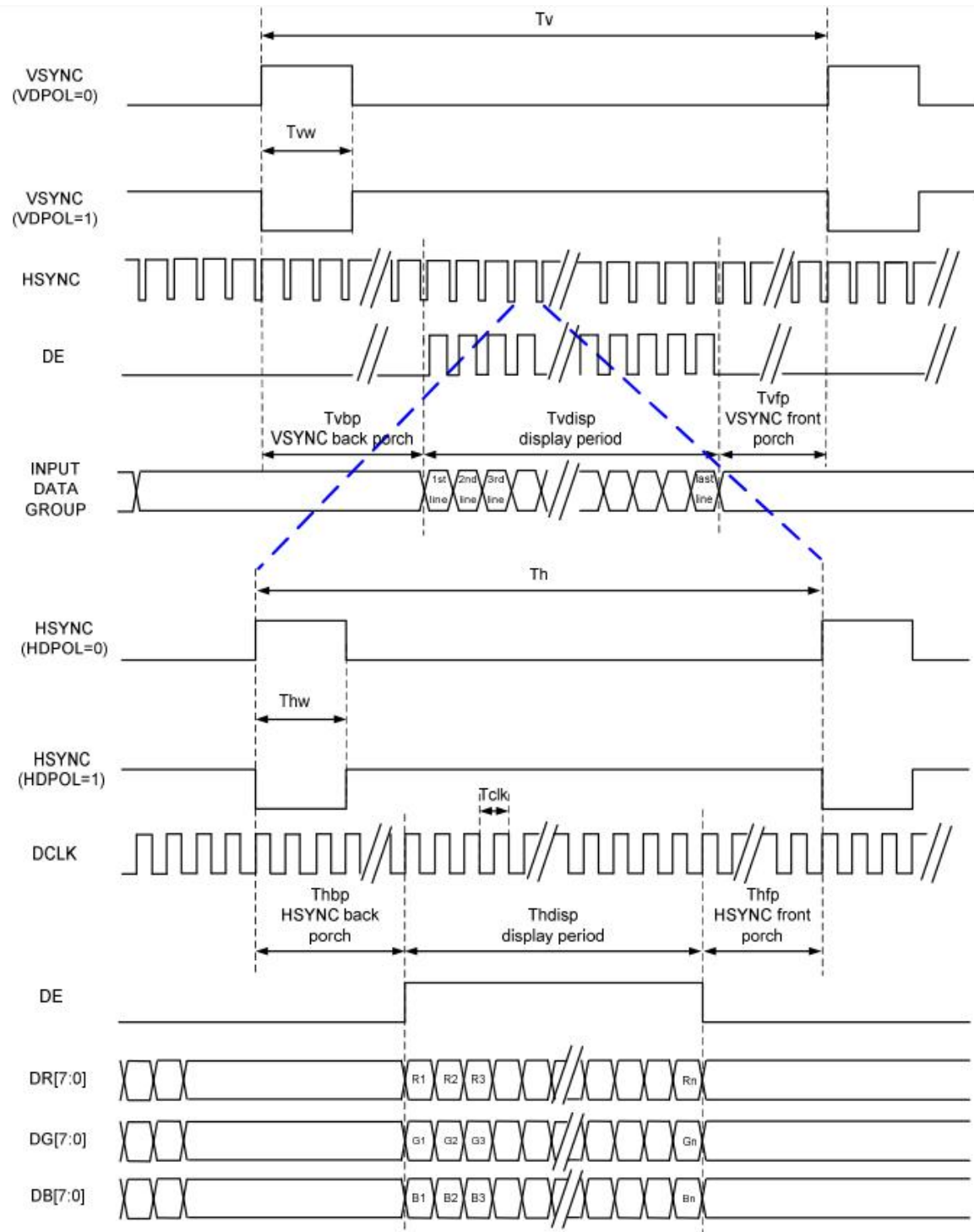

### 6.3. DE 模式 DE Mode

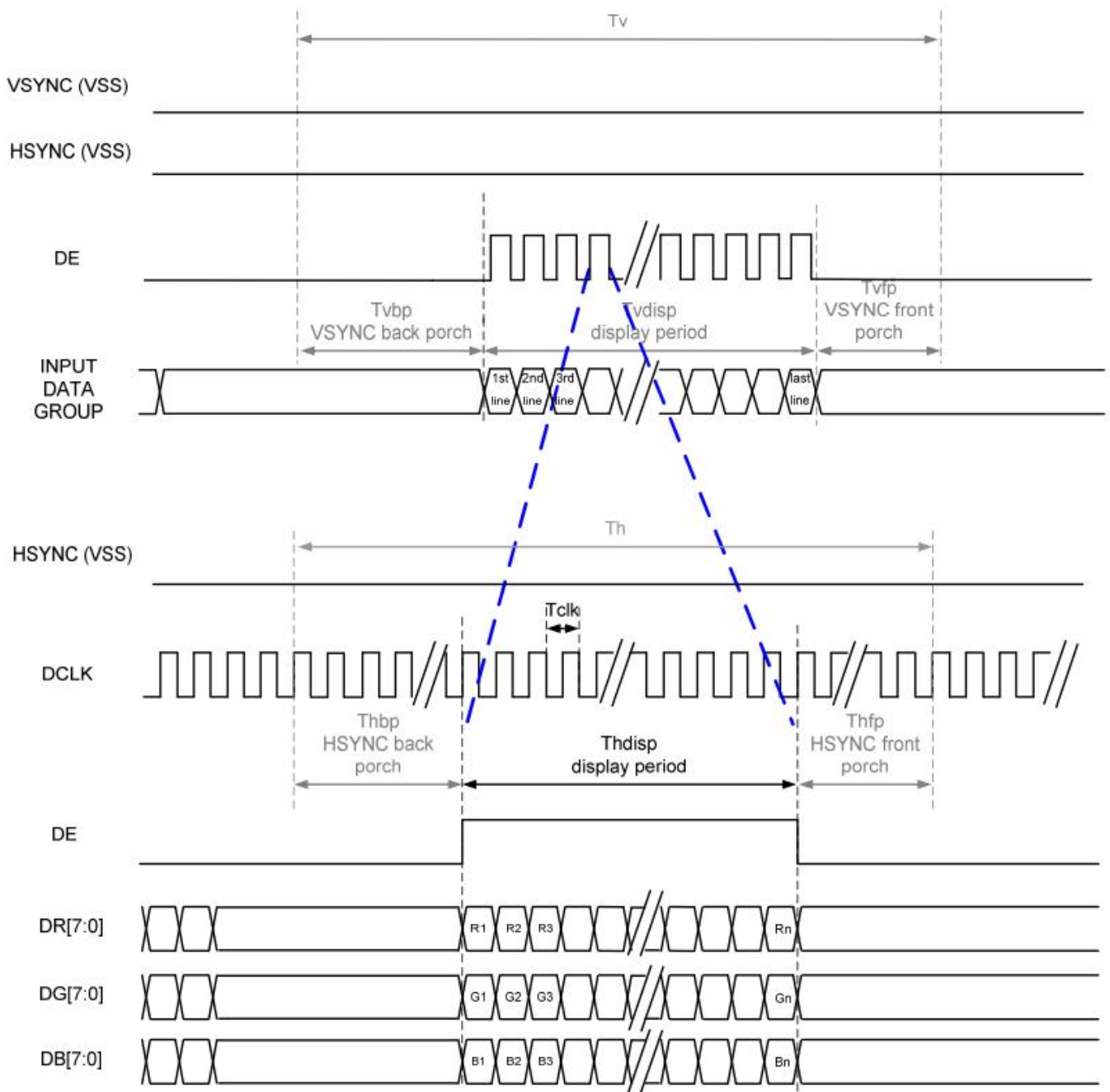



### 6.4. 并行 24 位 RGB 输入时序表 Parallel 24-bit RGB Input Timing Table

Parallel 24-bit RGB Input Timing (PVDD=VDD=VDDI= 3.3V, AGND= 0V, TA=25°C)

480RGB X 272 Resolution Timing Table							
Item	Symbol	Min.	Typ.	Max.	Unit	Remark	
DCLK Frequency	Fclk	8	9	12	MHz		
DCLK Period	Tclk	83	111	125	ns		
HSYNC	Period Time	Th	485	531	598	DCLK	
	Display Period	Thdisp		480		DCLK	
	Back Porch	Thbp	3	43	43	DCLK	By H_BLANKING setting
	Front Porch	Thfp	2	8	75	DCLK	
	Pulse Width	Thw	2	4	43	DCLK	
VSYNC	Period Time	Tv	276	292	321	HSYNC	
	Display Period	Tvdisp		272		HSYNC	
	Back Porch	Tvbp	2	12	12	HSYNC	By V_BLANKING setting
	Front Porch	Tvfp	2	8	37	HSYNC	
	Pulse Width	Tvw	2	4	12	HSYNC	

Note: It is necessary to keep Tvbp =12 and Thbp =43 in sync mode. DE mode is unnecessary to keep it.

### 6.5. 串行 8 位 RGB 输入时序表 Serial 8 bit RGB Input Timing Table

Serial 8-bit RGB Input Timing (PVDD=VDD=VDDI= 3.3V, AGND= 0V, TA=25°C)

480RGB X 272 Resolution Timing Table							
Item	Symbol	Min.	Typ.	Max.	Unit	Remark	
DCLK Frequency	Fclk	24	27	30	MHz		
DCLK Period	Tclk	33	37	42	ns		
HSYNC	Period Time	Th	1445	1491	1558	DCLK	
	Display Period	Thdisp		1440		DCLK	
	Back Porch	Thbp	3	43	43	DCLK	By H_BLANKING setting
	Front Porch	Thfp	2	8	75	DCLK	
	Pulse Width	Thw	2	4	43	DCLK	
VSYNC	Period Time	Tv	276	292	321	HSYNC	
	Display Period	Tvdisp		272		HSYNC	
	Back Porch	Tvbp	2	12	12	HSYNC	By V_BLANKING setting
	Front Porch	Tvfp	2	8	37	HSYNC	
	Pulse Width	Tvw	2	4	12	HSYNC	

Note: It is necessary to keep Tvbp =12 and Thbp =43 in sync mode. DE mode is unnecessary to keep it.

### 6.6. 开机上电顺序 Power-on sequence

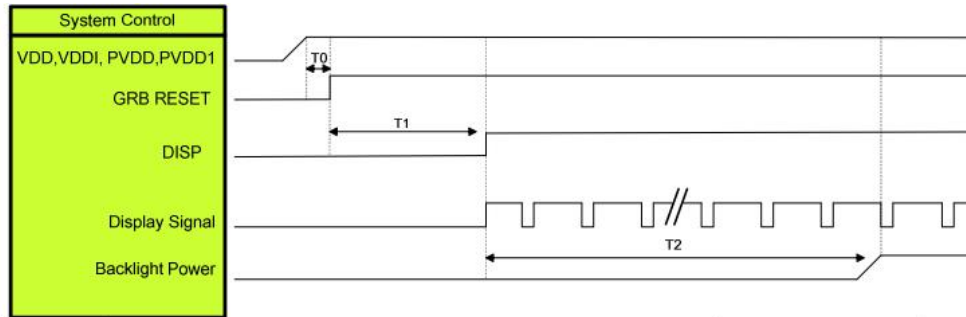

Symbol	Description	Min. Time	Unit
T0	System power stability to GRB RESET signal	0	ms
T1	GRB RESET="High" to DISP="High"	10	ms
T2	Display Signal output to Backlight Power on	250	ms

Note :

1. When DISP pull "H" or "L", IC will execute the internal power on or power off procedures .Please be careful about the timing of DISP and do not interrupt it during power on or power off procedure, otherwise unexpected errors will occur.
2. RGB interface Display signal: DCLK; VSYNC; HSYNC; DE; DR[7:0]; DG[7:0]; DB[7:0]

### 6.7. 关机下电顺序 Power-off sequence

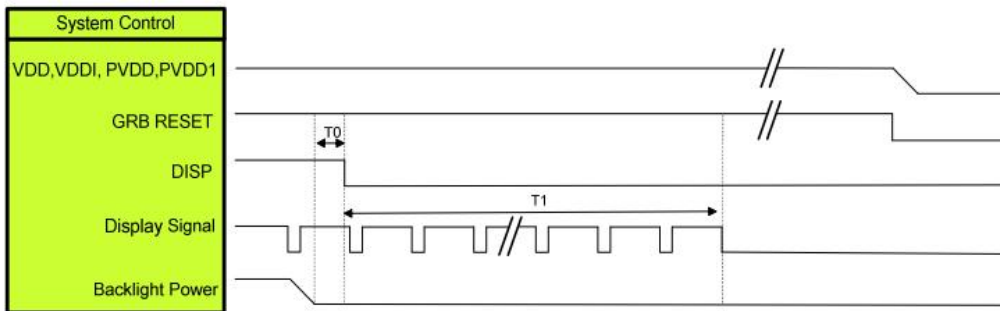

Symbol	Description	Min. Time	Unit
T0	Backlight Power off to DISP="Low"	5	ms
T1	DISP="Low" to IC internal voltage discharge complete	100	ms

Note :

1. When DISP pull "H" or "L", IC will execute the internal power on or power off procedures. Please be careful about the timing of DISP and do not interrupt it during power on or power off procedure, otherwise unexpected errors will occur.
2. RGB interface Display signal: DCLK; VSYNC; HSYNC; DE; DR[7:0]; DG[7:0]; DB[7:0]

## 七、可靠性测试 RELIABILITY TEST

### 7-1 温度和湿度 Temperature and Humidity

测试项目 TEST ITEMS	条件 CONDITIONS	注释 NOTE
高温储存 High Temperature Storage	Ta=+80°C, 120hrs	
低温储存 Low Temperature Storage	Ta=-30 °C, 120hrs	
高温运行试验 High Temperature Operation	Ta=+80 °C, 120hrs	
低温运行试验 Low Temperature Operation	Ta=-30 °C, 120hrs	
高温高湿（运行测试） High Temperature and High Humidity (Operating)	Ta=+60 °C, 90%RH Max, 120hrs	

#### 注释 Note:

1. 液晶驱动电压。由于液晶材料的特性，该电压随环境温度而变化。

Liquid Crystal driving voltage. Due to the characteristics of LC Material, this voltage varies with environmental temperature.

2. 温度和相对湿度范围如下图所示。湿球温度最高应为39°C。并且没有冷凝水。

Temperature and relative humidity range are shown in the figure below. Wet bulb temperature should be 39 °C max. and no condensation of water.

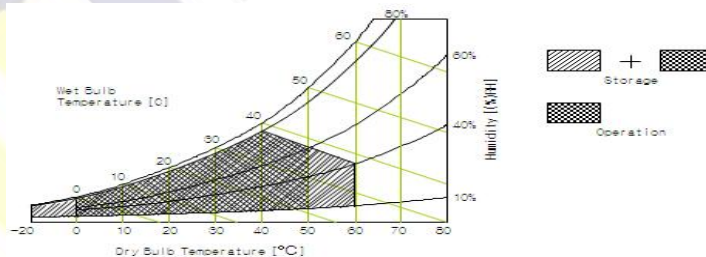

3. 产品经可靠性测试后，仅保证功能正常，无任何致命缺陷（不显示、线路缺陷、显示异常等）。

After the reliability test, the product only guarantee function normally without any fatal defect (non-display, line defect, abnormal display etc ).

4. 所有显示判断均在面板温度恢复到室温两小时后进行

All display judgments are performed two hours after the panel temperature returns to room temperature

5. Ta: 环境温度 Ambient temperature

**7-2 冲击和振动 Shock and Vibration**

测试项目 TEST ITEMS	条件 CONDITIONS
包装冲击(非操作) Packing Shock (Non-Operation)	<ul style="list-style-type: none"> <li>● Shock level:980m/s<sup>2</sup></li> <li>● Waveform:1/2 Sine wave,6msec</li> <li>● ±X, ±Y ±Z, each axis 1 times</li> </ul>
包装振动(非操作) Packing Vibration (Non-Operation)	<ul style="list-style-type: none"> <li>● Frequency range:8-33.3HZ</li> <li>● Stoke:1.0mm</li> <li>● Sweep: 10Hz-50Hz</li> <li>● x, y, z 2 hours for each direction</li> </ul>

**7-3 静电放电测试 Electrostatic Discharge**

测试项目 TEST ITEMS	条件 CONDITIONS
ESD (Non-operation)	150pF, 330 Ω , Contact ±2KV, Air : ±4KV. Note 1
	200pF, 0 Ω , ±200V Contact test. Note 2

**测量点 Measure Point:**

1. LCD玻璃和金属边框 LCD glass and metal bezel
2. 连接器引脚 IF connector pins

## 八、处理和注意事项 HANDDLING & CAUTIONS

### 8-1 操作注意事项 Caution For Operation

◆由于液晶模组是玻璃材质，请勿对其施加强烈的机械冲击或静载荷。请小心搬运，因为冲击、振动和粗心的搬运可能会严重影响产品。如果从高处坠落或受到强烈冲击，玻璃可能碎了。

Since the LCM is made of glass, do not apply strong mechanical impact or static load onto it. Handling with care since shock, vibration, and careless handling may seriously affect the product. If it falls from a high place or receives a strong shock, the glass maybe broken.

◆在规定的电压限制内驱动 LCM 是必不可少的，因为高于限制的电压会导致 LCM 的寿命缩短。由直流引起的电化学反应会导致 LCM 出现不良劣化，因此应避免使用直流驱动。

It is indispensable to drive the LCM within the specified voltage limit since the higher voltage than the limit causes LCM's life shorter. An electro-chemical reaction due to DC causes undesirable deterioration of the LCM so that the use of DC drive should avoid.

◆请勿在电源开启时将 LCM 连接到系统或从系统断开连接。

Do not connect or disconnect the LCM to or from the system when power is on.

◆切勿在高温高湿的异常条件下使用 LCM。

Never use the LCM under abnormal conditions of high temperature and high humidity.

◆当暴露于剧烈的温度波动（热到冷或冷到热）时，LCM可能会受到影响；具体来说，从冷到热的剧烈温度波动会在 LCM 表面产生露水，这可能会影响 LCM 上偏振片的运行。

When expose to drastic fluctuation of temperature (hot to cold or cold to hot), the LCM may be affected; specifically, drastic temperature fluctuation from cold to hot, produces dew on the LCM's surface which may affect the operation of the polarizer on the LCM.

◆在低于工作温度范围的温度下，响应时间将极度延迟，另一方面，在高于其工作范围的温度下，LCM 可能会变黑。然而，这些现象并不意味着 LCM 出现故障或故障。一旦温度恢复到正常运行的推荐温度范围，LCM 将恢复正常运行。

Response time will be extremely delay at lower temperature than the operating temperature range and on the other hand LCM may turn black at temperature above its operational range. However those phenomenon do not mean malfunction or out of order with the LCM. The LCM will revert to normal operation once the temperature returns to the recommended temperature range for normal operation.

◆为防止LCD产生图像残留，在使用常黑面板时不要长时间显示固定图案。如果LCD需要显示固定图案，建议时间少于 2 分钟或者更短的时间内刷新显示内容一次或多次。强烈建议使用黑色图像或移动图像作为屏幕保护程序。

In order to prevent the LCD from producing image retention, do not display a fixed pattern for a long time when using a normally black panel. If the LCD needs to display a fixed pattern, it is recommended to refresh the display one or more times in less



than 2 minutes or less. It is strongly recommended to use a black image or moving image as a screen saver.

## 8-2 防静电措施 Caution Against Static Charge

◆LCM 使用 C-MOS LSI 驱动器，因此建议客户将任何未使用的输入端连接到 Vdd 或 Vss，上电前不要输入任何信号，并将您的身体、工作/装配区、装配设备接地 防止静电。

The LCM use C-MOS LSI drivers, so customers are recommended that any unused input terminal would be connected to Vdd or Vss, do not input any signals before power is turn on, and ground you body, work/assembly area, assembly equipments to protect against static electricity.

◆缓慢去除保护膜，保持去除方向与面板表面不垂直约 30 度，如有可能，在离子风机等 ESD 控制装置下，工作室湿度应保持在 50%RH 以上，以减少静电风险

Remove the protective film slowly, keeping the removing direction approximate 30-degree not vertical from panel surface, if possible, under ESD control device like ion blower, and the humidity of working room should be kept over 50%RH to reduce the risk of static charge.

◆避免使用合成纤维制成的工作服。 我们推荐棉质衣服或其他经过导电处理的纤维。

Avoid the use work clothing made of synthetic fibers. We recommend cotton clothing or other conductivity-treated fibers.

◆在处理 LCM 时，请戴上不带电材料的手套。 对地导电手腕和对地导电鞋是必需的

In handling the LCM, wear non-charged material gloves. And the conducting wrist to the earth and the conducting shoes to the earth are necessary

## 文档修订记录 Document revision history :

版本 Version	日期 DATE	修改说明 Modify description	编制 PREPARED BY
0-0	2023-03-06	初次编制 First compilation.	Liu. YL

— — 结束 — —

— — END — —