

\*\*\*为防止LCD产生图像残留，在使用常黑面板时不要长时间显示固定图案。如果LCD需要显示固定图案，建议时间少于2分钟或者更短的时间内刷新显示内容一次或多次。  
 \*\*\*In order to prevent the LCD from producing image retention, do not display a fixed pattern for a long time when using a normally black panel. If the LCD needs to display a fixed pattern, it is recommended to refresh the display one or more times in less than 2 minutes or less.  
 强烈建议使用黑色图像或移动图像作为屏幕保护程序。It is strongly recommended to use a black image or moving image as a screen saver.

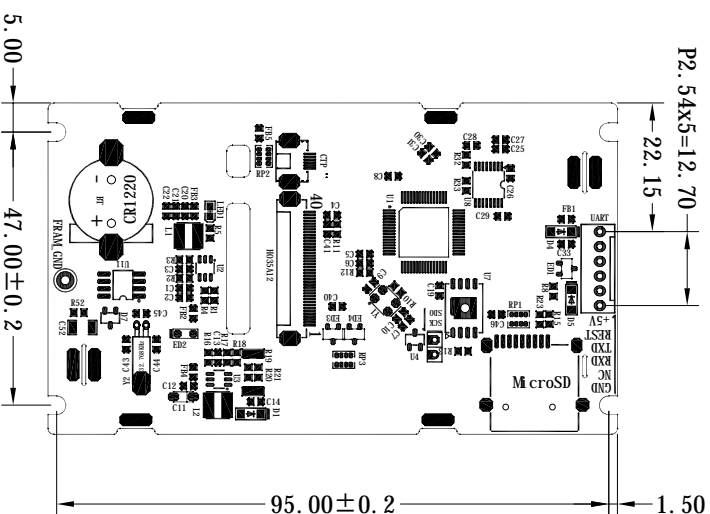

观看方向/角度 Viewing Direction	Full View(U80/D80/R80/L80)
接口 Interface	UART(TTL)/RS232
工作电压 Operating Voltage	+5V (Typ)
TFT 工作温度 TFT Operating Temp	-20 °C ~ 70 °C
TFT 储存温度 TFT Storage Temp	-30 °C ~ 80 °C
液晶模组亮度 LCM Brightness	800 cd/m <sup>2</sup> (Typ)/固定电流测试
触摸功能(TP) Touch Function	<input checked="" type="checkbox"/> 无触摸MTP <input type="checkbox"/> 电阻触摸RTP <input type="checkbox"/> 电容触摸CTP

6 Pin, P2.54mm	
1	+5V
2	NC
3	TXD
4	RXD
5	NC
6	GND

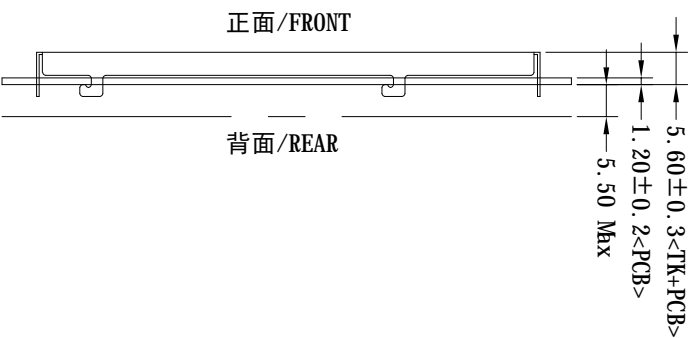
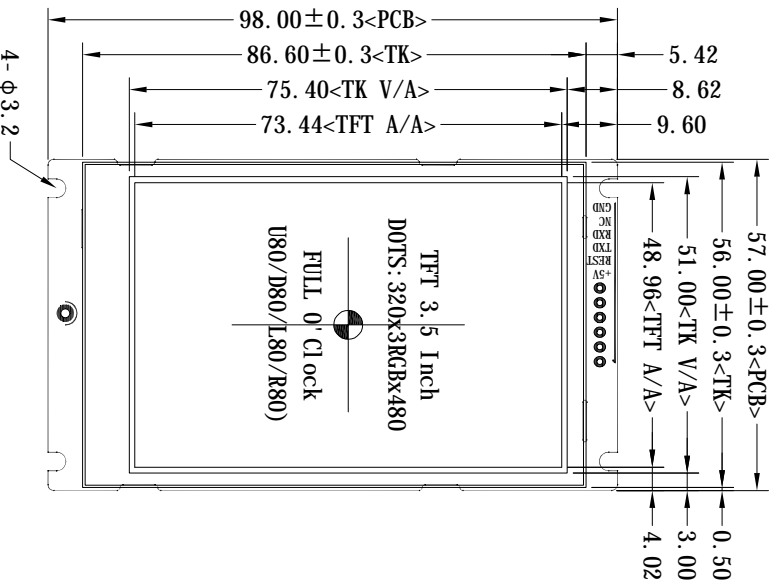
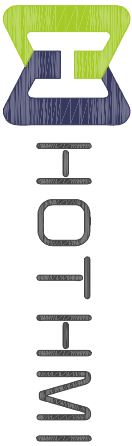

**HOT-HMI**

产品型号 Product model	HTM-H035A12-A9-UART		
比例 Scale	1:1	设计制图 Design	Li u. YL
版本 Ver	V0-0	单位 Unit	MM
		公差 Tol.	±0.3
		日期 Date	2023-04-04

\*\*\*为防止LCD产生图像残留，在使用常黑面板时不要长时间显示固定图案。如果LCD需要显示固定图案，建议时间少于 2 分钟或者更短的时间内刷新显示内容一次或多次。  
 \*\*\*In order to prevent the LCD from producing image retention, do not display a fixed pattern for a long time when using a normally black panel. If the LCD needs to display a fixed pattern, it is recommended to refresh the display one or more times in less than 2 minutes or less.  
 强烈建议使用黑色图像或移动图像作为屏幕保护程序。It is strongly recommended to use a black image or moving image as a screen saver.

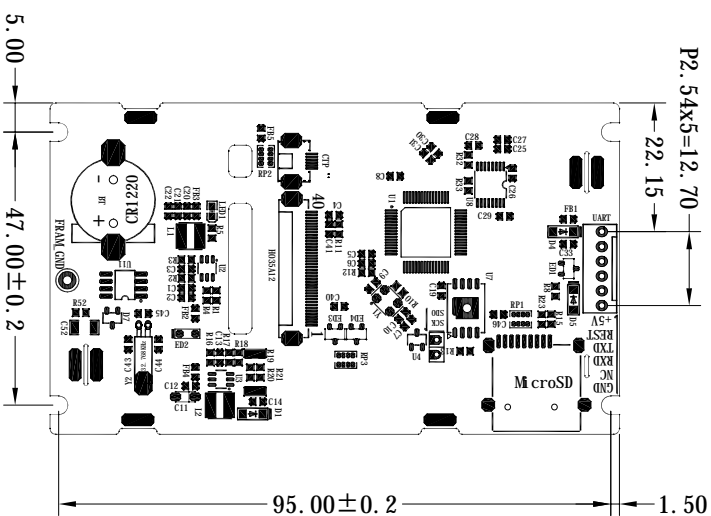
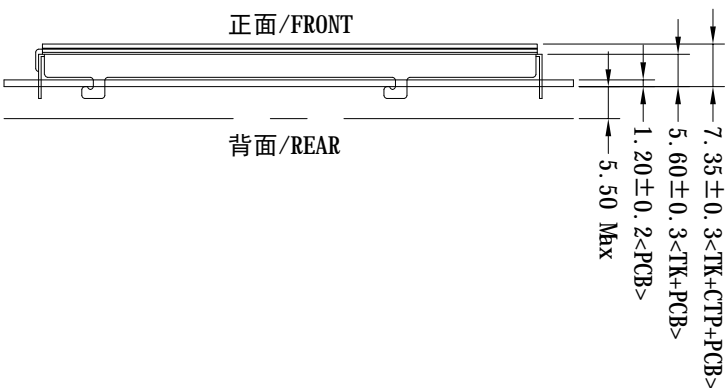
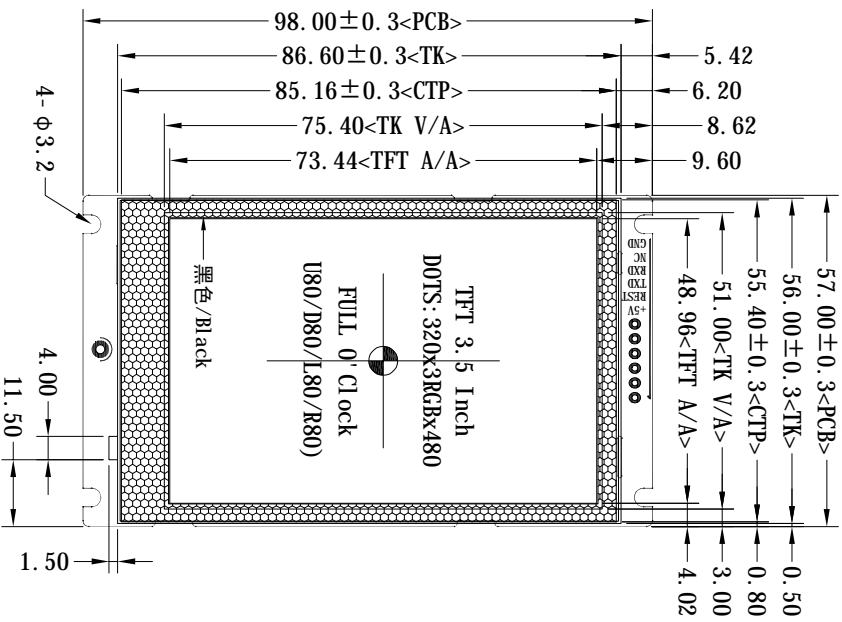

观看方向/角度 Viewing Direction	Full View(U80/D80/R80/L80)
接口 Interface	UART(TTL)/RS232
工作电压 Operating Voltage	+5V (Typ)
TFT 工作温度 TFT Operating Temp	-20 °C ~ 70 °C
TFT 储存温度 TFT Storage Temp	-30 °C ~ 80 °C
液晶模组亮度 LCM Brightness	600 cd/m <sup>2</sup> (Typ)/固定电流测试
触摸功能(TP) Touch Function	<input type="checkbox"/> 无触摸MTP <input type="checkbox"/> 电阻触摸RTP <input checked="" type="checkbox"/> 电容触摸CTP

6 Pin, P2.54mm	
1	+5V
2	NC
3	TXD
4	RXD
5	NC
6	GND

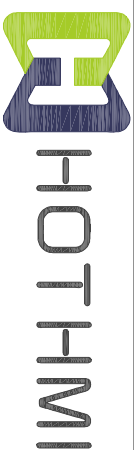

产品型号 Product model	HTM-H035A12-A9C-UART		
比例 Scale	1:1	设计制图 Design	Li u. YL
版本 Ver	V0-1	单位 Unit	MM
		公差 Tol.	±0.3
		日期 Date	2023-04-04