

**DOT MATRIX
LIQUID CRYSTAL DISPLAY
MODULE**

HTM240128A

USER' MANUAL

PROPOSED BY		APPROVED
Design	Approved	

CONTENTS

	PAGE
1. GENERAL AND MECHANICAL	2
2. ABSOLUTE MAXIMUM RATINGS	2
2.1 Electrical absolute maximum ratings	2
2.2 Environmental absolute maximum ratings	2
3. ELECTRICAL CHARACTERISTICS	3
4. ELECTRO-OPTICAL CHARACTERISTICS	3
5. BLOCK DIAGRAM AND POWER SUPPLY	4
6. TIMING CHARACTERISTICS	4
7. DIMENSION OUTLINE AND PIN CONNECTIONS	5
8. POWER SUPPLY FOR BACKLIGHT	5
9. DISPLAY CONTROL INSTRUCTIONS	6
9.1 Command list	6
9.2 Description of command	7
9.3 Flowchart of communications with MPU	13
9.4 Initialize	14
10. RELIABILITY CONDITION	15
11. FUNCTIONAL TEST & INSPECTION CRITERIA	15
12. CG ROM PATTERN	16

1. GENERAL AND CHARACTERISTICS

Dot Matrix Format	240 × 128 dots
Controller IC	T6963C or equivalent
Dimensional Outline	144.0W × 104.0H × 14.6D mm
Viewing Area	114.0W × 64.0H mm
Active Viewing Area	107.95W × 57.55H mm
Dot Pitch	0.45W × 0.45H mm
Dot Size	0.40W × 0.40H mm
LCD TYPE	STN, Blue, 1/128 Duty, 1/12 Bias, 6 O'clock, LED Backlight (Color is White)
Backlight	LED Backlight (Color is White)

2. ABSOLUTE MAXIMUM RATINGS:

2.1 Electrical absolute maximum rating

ITEM	SYMBOL	MIN	MAX	UNIT
Logic Circuit Supply Voltage	$V_{DD} - V_{SS}$	0	7.0	V
LCD Driver Circuit Supply Voltage	$V_{DD} - V_{EE}$	0	15.0	V
Input Voltage	V_I	V_{SS}	V_{DD}	V
Operating Temperature	T_{OP}	0	+50	°C
Storage Temperature	T_{ST}	-10	+60	°C

2.2 Environmental absolute maximum ratings

ITEM	OPERATING		STORAGE		COMMENT
	MIN	MAX	MIN	MAX	
Ambient Temperature	0/-20	50/70	-10/-30	60/80	Norm/Extended Note (1)
Humidity	Note (2)		Note (2)		Without condensation
Vibration	--	4.9m/s ²	--	19.6m/s ²	XYZ directions
Shock	--	29.4m/s ²	--	490.0m/s ²	XYZ directions

Note (1) T_a at 60°C : 50 HR MAX

Note (2) $T_a \leq 40^\circ\text{C}$: 90% RH MAX

$T_a > 40^\circ\text{C}$: Absolute humidity must be lower than the humidity of 90% at 40°C.

(Note 1) Definition of response time and measuring condition. Response time should be measured at the point of the most smallest response in all segments under the following condition.

- Temperature 25°C
- Frame frequency 64 Hz
- Viewing angle $\theta = 0^\circ$, $\phi = 0^\circ$

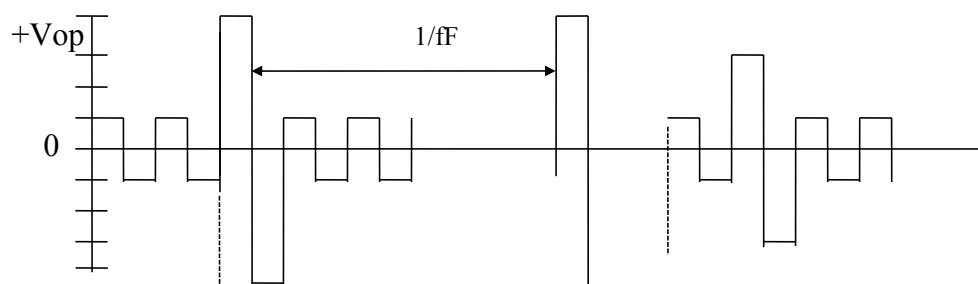

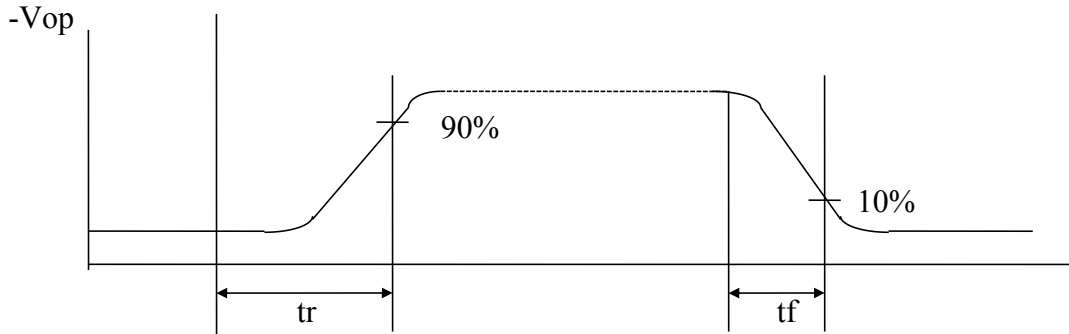

(Note 2) Definition of viewing angle
Front-Rear direction

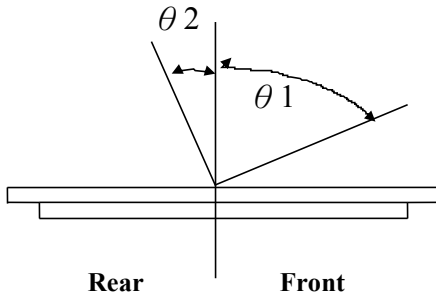

Right-Left direction

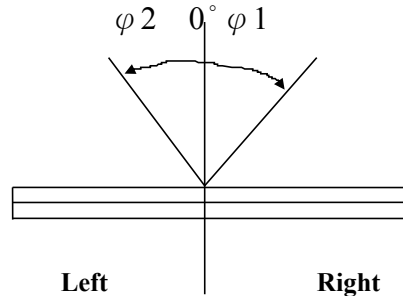

3. ELECTRICAL CHARACTERISTICS

$V_{SS} = 0V, T_a = 25^\circ C$

ITEM	SYMBOL	CONDITION	MIN	TYP	MAX	UNIT
Logic Circuit Power Supply	$V_{DD} - V_{SS}$	--	4.75	5.0	5.25	V
LCD Driver Power Supply	$V_{DD} - V_{EE}$	--	--	9.0	--	V
Input Voltage	V_{IH}	$V_{DD} = 5V \pm$	$0.7 * V_{DD}$	--	V_{DD}	V
	V_{IL}	0.25	0	--	$0.3 * V_{DD}$	V
Power Supply Current	I_{DD}	$V_{DD} = 5V$	--	--	12.0	mA
	I_{EE}	$V_{EE} = -10V$	--	--	2.0	mA

4. ELECTRO-OPTICAL CHARACTERISTICS

ITEM	SYMBOL	CONDITION	MIN	TYP	MAX	UNIT	REF.
Rise Time	T_r	$25^\circ C$	--	396	--	mS	Note 1
Fall Time	T_f	$25^\circ C$	--	109	--	mS	Note 1
Contrast	Cr	$25^\circ C$	--	12.3	--	--	Note 3
Viewing Angle	θ	$25^\circ C \ \&$	50	--	--	DEG	Note 2
	ϕ_1, ϕ_2	$Cr \geq 3$	--	40	--	DEG	Note 2
Frame Frequency	F_f	$25^\circ C$	--	64	--	Hz	--

Note 1&2 : See previous page.

Note 3 : Contrast ration is defined under the following condition.

$Cr = \text{reflectance value of non-selected condition} \div \text{reflectance value of selected condition.}$

- (a) Temperature..... $25^\circ C$
- (b) Frame frequency..... 64 Hz
- (c) Viewing angle..... $\theta = 0^\circ, \phi = 0^\circ$
- (d) Operating voltage..... 12.5V

5. BLOCK DIAGRAM AND POWER SUPPLY

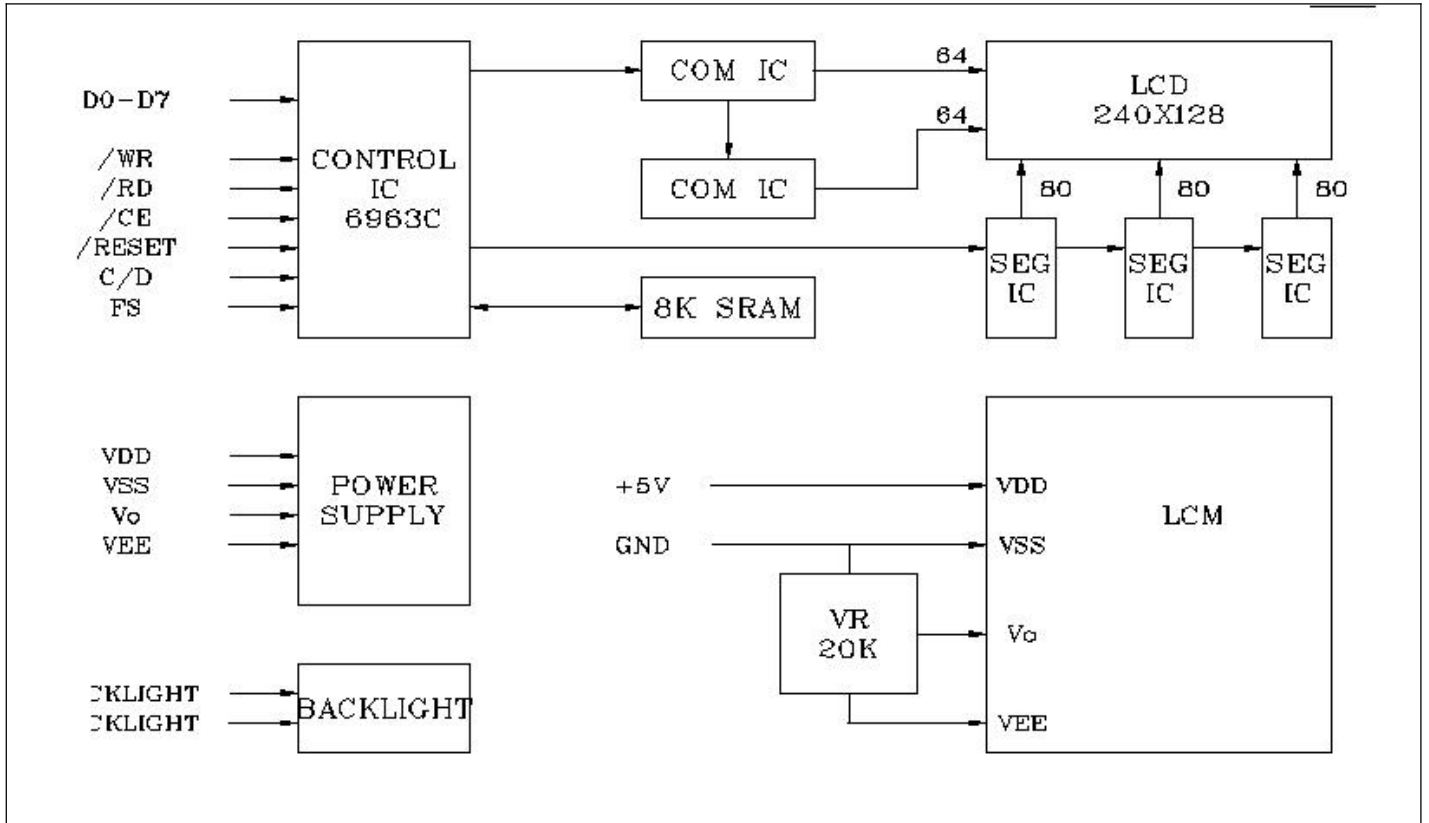

6. TIMING CHARACTERISTICS

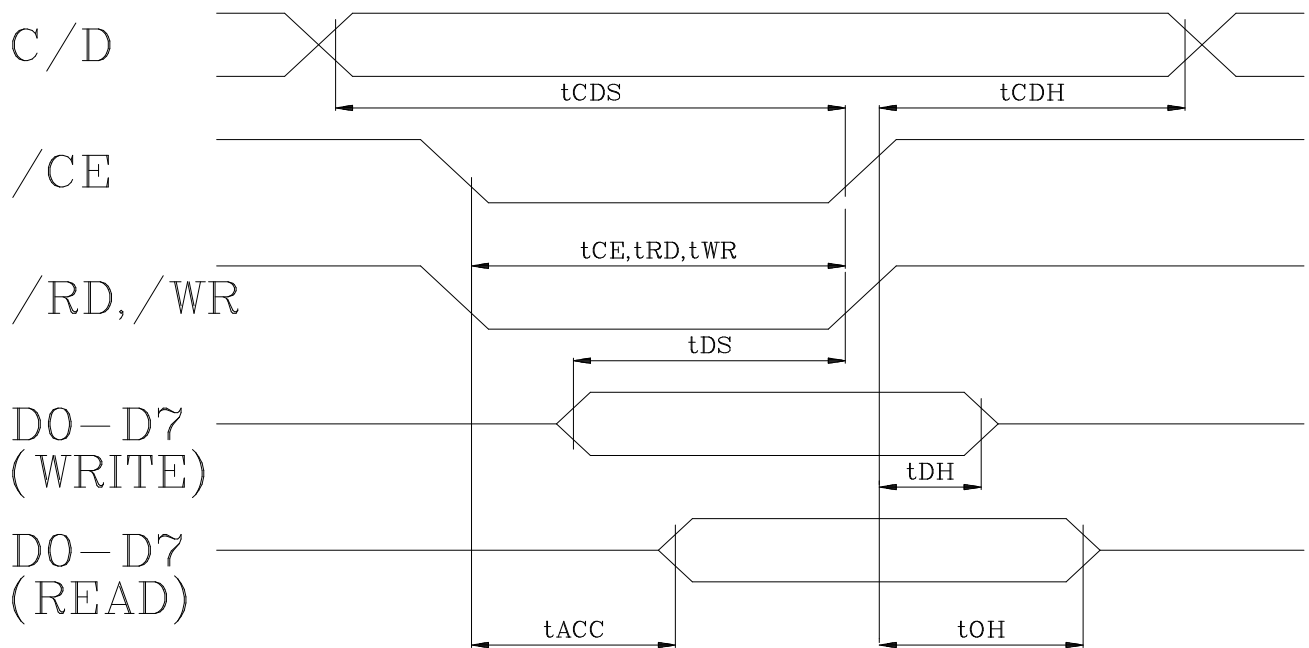

ITEM	SYMBOL	MIN	TYP	MAX	UNIT
C/D Set Up Time	tCDS	100	--	--	ns

C/D Hold Time	tCDH	10	--	--	ns
/CE, /RD, /WR Pulse Width	tCE, tRD, tWR	80	--	--	ns
Data Set Up Time	tDS	80	--	--	ns
Data Hold Time	tDH	40	--	--	ns
Access Time	tACC	--	--	150	ns
Output Hold Time	tOH	--	--	50	ns

PAGE 4

7. DIMENSION OUTLINE AND PIN CONNECTIONS

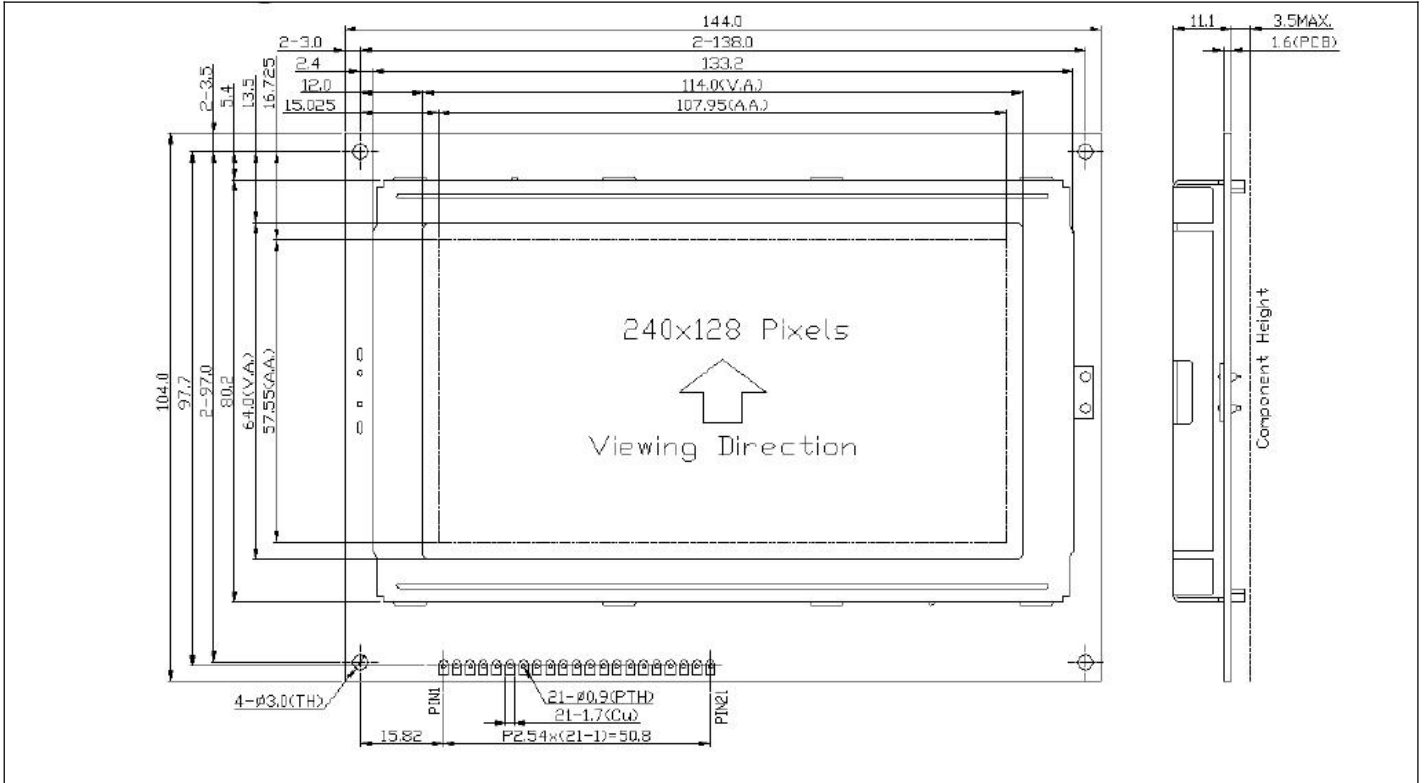

NO.	SYMBOL	FUNCTION	NO.	SYMBOL	FUNCTION
1	FGND	Frame ground	10	DB0	Data bus line
2	V _{SS}	Ground potential (Logic)	11	DB1	Data bus line
3	V _{DD}	Power supply for logic circuit	12	DB2	Data bus line
4	V _O	Power supply for LCD circuit	13	DB3	Data bus line
5	/WR	Data write	14	DB4	Data bus line
6	/RD	Data read	15	DB5	Data bus line
7	/CE	Chip enable	16	DB6	Data bus line
8	C/D	Command/Data	17	DB7	Data bus line
9	/RES	Controller reset	18	FS	Font select H:6x8 L:8x8
			19	V _{EE}	Negative voltage output for LCD
			20	BLA	Backlight Power Supply Anode
			21	BLK	Backlight Power Supply Cathode

8. POWER SUPPLY FOR BACKLIGHT

ITEM	LED Backlight	EL Backlight	CCFL Backlight
Use Inverter Type	--		
Color	White		
Backlight Input Voltage	DC +5.0 V		
Backlight Frequency	--		
Backlight Current	180 mA		
Inverter Input Voltage	--		
Inverter Current Density	--		

Half-Life Time	30,000 HR.		
----------------	------------	--	--

PAGE 5

9. DISPLAY CONTROL INSTRUCTION

9.1 Command list

COMMAND	OCDE	D1	D2	FUNCTION
REGISTER SET	00100001	X adrs	Y adrs	CURSOR POINTER SET
	00100010	data	00H	OFFSET REGISTER SET
	00100100	Low adrs	High adrs	ADDRESS POINTER SET
CONTROL WORD SET	01000000	Low adrs	High adrs	TEXT HOME ADDRESS SET
	01000001	Columns	00H	TEXT AREA SET
	01000010	Low adrs	High adrs	GRAPHIC HOME ADDRESS SET
	01000011	Columns	00H	GRAPHIC AREA SET
MODE SET	1000X000	-	-	“OR” mode
	1000X001	-	-	“EXOR mode
	1000X011	-	-	“AND” mode
	1000X100	-	-	“TEXT ATTRIBUTE” mode
	10000XXX	-	-	Internal CG ROM Mode
	10001XXX	-	-	External CG RAM mode
DISPLAY MODE	10010000	-	-	DISPLAY OFF
	1001XX10	-	-	CURSOR ON, BLINK OFF
	1001XX11	-	-	CURSOR ON, BLINK ON
	100101XX	-	-	TEXT ON, GRAPHIC OFF
	100110XX	-	-	TEXT OFF, GRAPHIC ON
	100111XX	-	-	TEXT ON, GRAPHIC ON
CURSOR PATTERN SELECT	10100000	-	-	1 LINE CURSOR
	10100001	-	-	2 LINES CURSOR
	10100010	-	-	3 LINES CURSOR
	10100011	-	-	4 LINES CURSOR
	10100100	-	-	5 LINES CURSOR
	10100101	-	-	6 LINES CURSOR
	10100110	-	-	7 LINES CURSOR
	10100111	-	-	8 LINES CURSOR
DTAT AUTO READ/WRITE	10110000	-	-	DATA AUTO WRITE SET
	10110001	-	-	DATA AUTO READ SET
	10110010	-	-	AUTO RESET
DATA READ WRITE	11000000	data	-	DATA WRITE AND ADP INCREMENT
	11000001	-	-	DATA READ AND ADP INCREMENT
	11000010	data	-	DATA WRITE AND ADP DECREMENT
	11000011	-	-	DATA READ AND ADP DECREMENT
	11000100	data	-	DATA WRITE AND ADP NONVARIABLE
	11000101	-	-	DATA READ AND ADP NONVARIABLE
SCREENPEEK	11100000	-	-	SCREEN PEEK
SCREEN COPY	11101000			SCREEN COPY
	11110XXX	-	-	BIT RESET
	11111XXX	-	-	BIT SET
	1111X000	-	-	BIT0 (LSB)
	1111X001	-	-	BIT1

BIT	1111X010	-	-	BIT2
SET/	1111X011	-	-	BIT3
RESET	1111X100	-	-	BIT4
	1111X101	-	-	BIT5
	1111X110	-	-	BIT6
	1111X111	-	-	BIT7 (MSB)

- Note 1:** Status check between all commands and data is recommended , though execution time for several commands are specified in above command list.
 For the commands with “status check” in execution time, execution time does not specified because it is infunced by internal situation of controller LSI.
- 2 :** In case of 2 screen mode , Screen copy command cannot be used.

PAGE 6

9.2 Description of command

9.2.1 Register set

CODE	FUNCTION	D1	D2
00100001 21H	CURSOR POINTER SET	X address	Y address
00100010 22H	OFFSET REGISTER SET	DATA	00H
00100100 24H	ADDRESS POINTER SET	LOW address	HIGH address

A) CURSOR POINTER SET

The position of cursor is specified by X ADRS, Y ADRS, The cursor position is moved only by this command. The cursor pointer doesn't have the function of increment and decrement. The shift of cursor are set by this command.

X ADRS, Y ADRS are specified following

- X ADRS 00H~4FH (lower 7bits are valid)
- Y ADRS 00H~1FH (lower 5bits are valid)

1) 1 screen drive

X ADRS 00~4FH

Y ADRS 00H~0FH

2) 2 screen drive

X ADRS 00~4FH

Y ADRS 00H~0FH upper screen

Y ADRS 10H~1FH lower screen

B) OFFSET REGISTER SET

The offset register is used to determine external character generator RAM area.

C) ADDRESS POINT SET

The address point set command is used to indicate the start address for writing (or read) to external RAM.

9.2.2 Control word set

CODE	FUNCTION	D1	D2
01000000 40H	TEXT HOME ADDRESS SET	Low address	High address
01000001 41H	TEXT AREA SET	Columns	00H
01000010 42H	GRAPHIC HOME ADDRESS SET	Low address	High address
01000011 43H	GRAPHIC AREA SET	Columns	00H

The home address and column size are defined by this command.

A) Text home address set

The starting address of external display RAM for Text display is defined by this command. The text home address shows the left end and most upper position.

The relationship of external display RAM address and display position

TH		TH + CL
TH + TA		TH + TA + CL
(TH + TA) + TA		TH + 2TA + CL
(TH + 2TA) + TA		TH + 3TA + CL

TH + (n-1) TA		TH + (n-1) TA + CL
---------------	--	--------------------

TH: Text Home address **TA: Text Area number (columns)**
CL: Columns are fixed by hardware, pin-programmable

ex) **Text home address = 0000H** **Text area = 0020H**
MD2=H, MD3=H **:32 columns**
DUAL=H, MDS=L, MDO=L, MD1=H **:4 lines**

0000H	0001H		001EH	001FH
0020H	0021H		003EH	003FH
0040H	0041H		005EH	005FH
0060H	0061H		007EH	007FH

PAGE 7

B) Graphic home address set

The starting address of external display RAM for Graphic display is defined by this command.
The graphic home address shows the left end and most upper line.

The relationship of external display RAM address and display position

GH		GH+CL
GH+GA		CH+GA+CL
(GH+GA)+GA		GH+2GA+CL
(GH+2GA)+GA		GH+3GA+CL
GH+(n-1)GA		GH+(n-1)GA+CL

GH: Graphic Home address **GA: Graphic area number (columns)**
CL: Columns are fixed by hardware. (pin-programmable)

ex) **Graphic home address = 0000H** **Graphic area = 0020H**
MD2=H, MD3=H **:32 columns**
DUAL=H, MDS=L, MD0=M, MD1=H **:2 lines**

0000H	0001H		001EH	001FH
0020H	0021H		003EH	003FH
0040H	0041H		005EH	005FH
0060H	0061H		007EH	007FH
0080H	0081H		009EH	009FH
00A0H	00A1H		00BEH	00BFH
00C0H	00C1H		00DEH	00DFH
00E0H	00E1H		00FEH	00FFH
0100H	0101H		011EH	011FH
0120H	0121H		013EH	013FH
0140H	0141H		015EH	015FH
0160H	0161H		017EH	017FH
01A0H	01A1H		01BEH	01BFH
01C0H	01C1H		01DEH	01DFH
01E0H	01E1H		01FEH	01FFH

C) Text area set

The columns of display are defined by the hardware setting. This command can be used to adjust columns of display.

ex) **LCD size: 20 columns, 4 lines**
Text home address = 0000H **Text area = 0014H**
MD2=H, MD3=H **: 32 columns**
DUAL=h, MDS=L, MD0=L, MD1=H **:4 lines**

0000	0001	0013	0014	001F
0014	0015	0027	0028	0033
0028	0029	003B	003C	0047

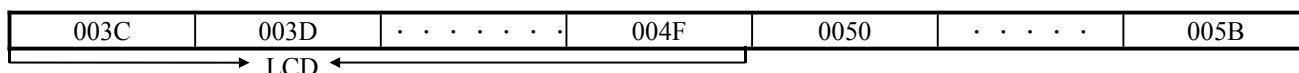

D) Graphic area set

The columns of display are defined by the hardware setting. This command can be used to adjust columns of graphic display.

ex) LCD size: 20 columns, 2 lines

Text home address = 0000H Text area = 0014H

MD2=H, MD3=H : 32 columns

DUAL=H, MDS=L, MD0=H, MD1=H : 2 lines

PAGE 8

0000	0001	0013	0014	001F
0014	0015	0027	0028	0033
0028	0029	003B	003C	0047
003C	003D	004F	0050	005B
0050	0051	0063	0064	006F
0064	0065	0077	0078	0083
0078	0079	008B	008C	0097
008C	008D	009F	00A0	00AB
00A0	00A1	00B3	00B4	00BF
00B4	00B5	00C7	00C8	00D3
00C8	00C9	00DB	00DC	00E7
00DC	00DD	00EF	00F0	00FD
00F0	00F1	0103	0104	011F
0104	0105	0127	0128	0123
0118	0119	012B	012C	0137
012C	012D	013F	0140	014B

→ LCD ←

The address in graphic area can be continuous and RAM area can be used without ineffective area, if graphic area is defined the same number as the actual column number of LCD display.

9.2.3 Mode set

CODE	FUNCTION
1000X000	“OR” mode
1000X001	“EXOR” mode
1000X011	“AND” mode
1000X100	“TEXT ATTRIBUTE” mode
10000XXX	internal character generator mode
10001XXX	external character generator mode

The display mode is defined by this command. The display mode doesn’t change until this command is sent. Logically “OR”, “EXOR”, “AND” of text and graphic display can be displayed. When internal character generator mode is selected, character code 00H~7FH are selected from built-in character generator RM. The character code 80H~FFH are automatically selected from external character generator RAM.

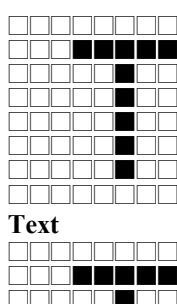
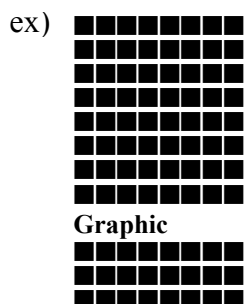

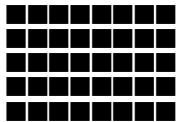

“OR”

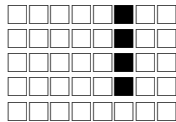

“AND”

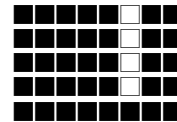

“EXOR”

Note: Only text display is attributed, because attribute data is located in graphic RAM area.

A) Attribute function

“Reverse display”, “Character blink” and “Inhibit” are called “Attribute”. The attribute data is written in the graphic area defined by Control word set command. The mode set command selects text display only and graphic display cannot be displayed.

The attribute data of the 1st character in text area is written at the 1st 1 byte in graphic area, and attribute data of n-th character is written at the n-th 1 byte in graphic area. Attribute function is defined as follows:

PAGE 9

Attribute RAM 1 Byte				X	X	X	X	d3	d2	d1	d0
d3	d2	d1	d0	FUNCTION							
0	0	0	0	normal display							
0	1	0	1	reverse display							
0	0	1	1	inhibit display							
1	0	0	0	blink of normal display							
1	1	0	1	blink of reverse display							
1	0	1	1	blink of inhibit display							

X: don't care

9.2.4 Display mode

CODE	FUNCTION
10010000	display off
1001XX10	cursor on, blink off
1001XX11	cursor on, blink on
100101XX	text on, graphic off
100110XX	text off, graphic on
100111XX	text on, graphic on

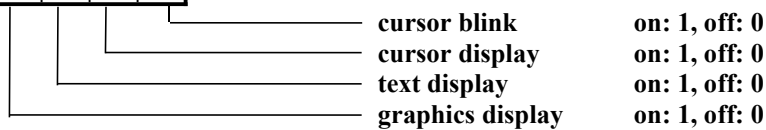
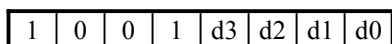

Note: It is necessary to turn on “text” display“ and ”graphic display“ in following case.

- 1) Combination of text/graphic display
- 2) Attribute function

9.2.5 Cursor pattern select

CODE	FUNCTION	CODE	FUNCTION
10100000	1 line cursor	10100100	5 lines cursor
10100001	2 lines cursor	10100101	6 lines cursor
10100010	3 lines cursor	10100110	7 lines cursor
10100011	4 lines cursor	10100111	8 lines cursor

When cursor display is ON, this command selects the cursor pattern from 1 line to 8 lines. The cursor address is defined by cursor pointer set command.

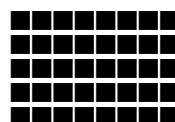
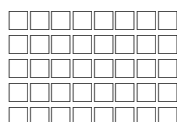
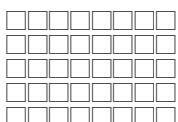

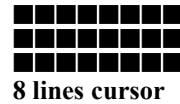
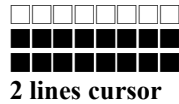
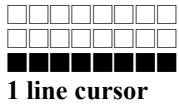

9.2.6 Data auto read/write

CODE	FUNCTION
10110000 B0H	data auto write set
10110001 B1H	data auto read set
10110010 B2H	auto reset

This command is convenient to send full screen data from external display RAM. After setting auto mode, “data write (or read)” command is not necessary between each data. “Data auto write (or read)” command should follow the “Address pointer set” and address pointer is automatically increment by +1 after each data “auto reset” is necessary to return normal operation because all data is regarded “display data” and no command can be accepted in the auto mode.

Note: Status check for auto mode (STA2, STA3 should be checked between each data. Auto reset should be performed after checking STA3=1 (STA2=1)).

PAGE 10

Refer following flow chart.

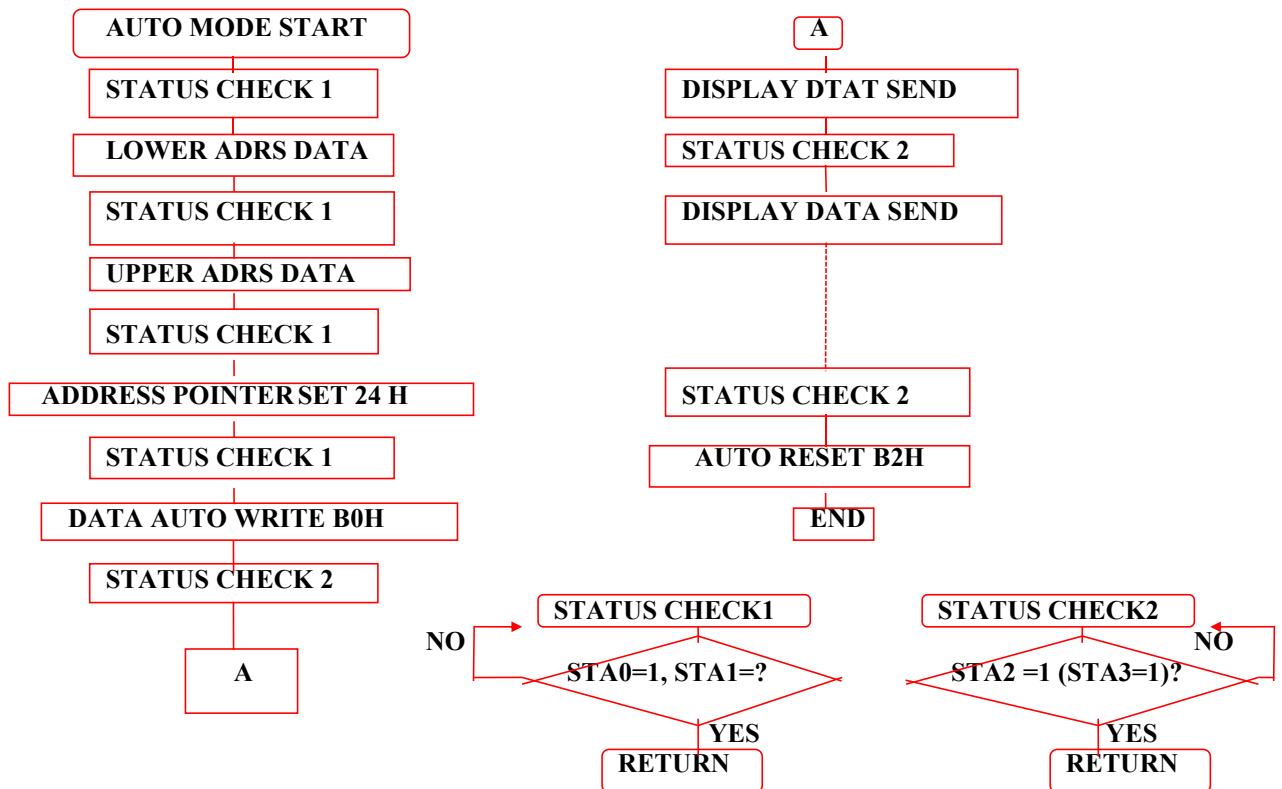

9.2.7 Data read write

CODE	FUNCTION	OPERAND
11000000 C0H	DATA WRITE AND ADP INCREMENT	data
11000001 C1H	DATA READ AND ADP INCREMENT	-
11000010 C2H	DATA WRITE AND ADP DECREMENT	data
11000011 C3H	DATA READ AND ADP DECREMENT	-
11000100 C4H	DATA WRITE AND ADP NONVARIABLE	data
11000101 C5H	DATA READ AND ADP NONVARIABLE	-

This command is used for data write from MPU to external display RAM to MPU. Data write/read should be executed after setting address by address pointer can be automatically increment or decrement by setting this command.

Note: This command is necessary for each 1 byte data. Refer following flow chart.



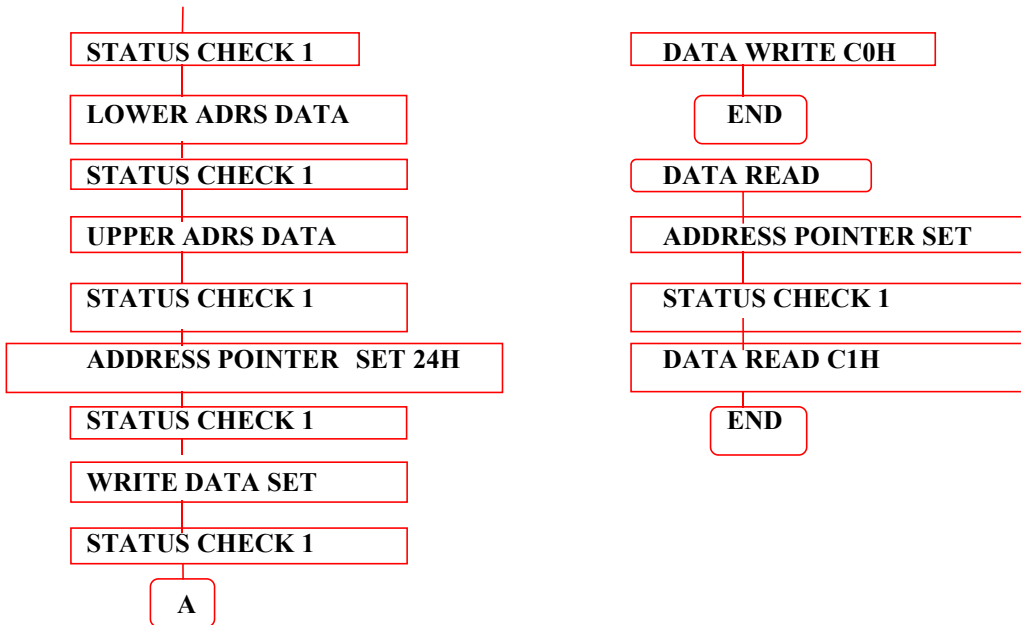

PAGE 11

9.2.8 Screen peek

CODE	FUNCTION	OPERAND
11100000 E0H	screen peek	-

This command is used to transfer displayed 1 byte data to data stack, and this 1 byte data can be read from MPU by data access.

The logical combination data of text and graphic display on LCD screen can be read by this command. The status (STA6) should be checked just after “screen peek” command. If the address command is not in graphic area, this command ignored and status flag (STA6) is set.

Refer following flow chart.

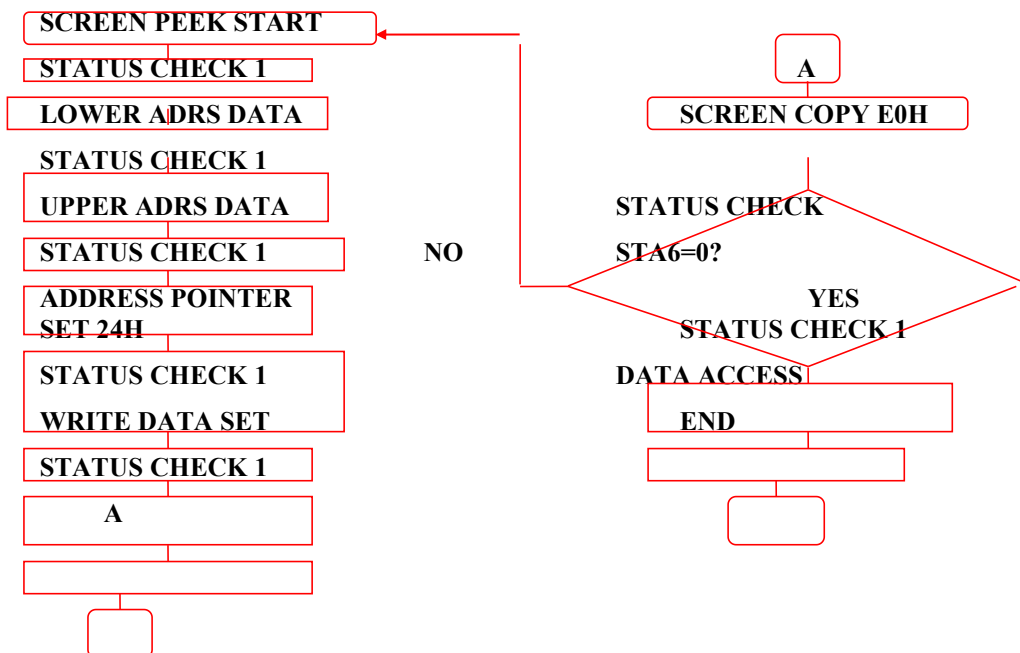

9.2.9 Screen copy

CODE	FUNCTION	OPERAND
11101000 E8H	screen copy	-

This command is used to copy displayed 1 line data to graphic area. The start point of 1 line data in the screen is determined by the address pointer.

Note:a) When the attribute of text is used this command cannot be used. (because attribute data is in the graphic area.)
 b) In case of 2 screen drive, this command cannot be used. (because T6963c cannot separate upper screen data and lower screen data.)

Refer following flow chart.

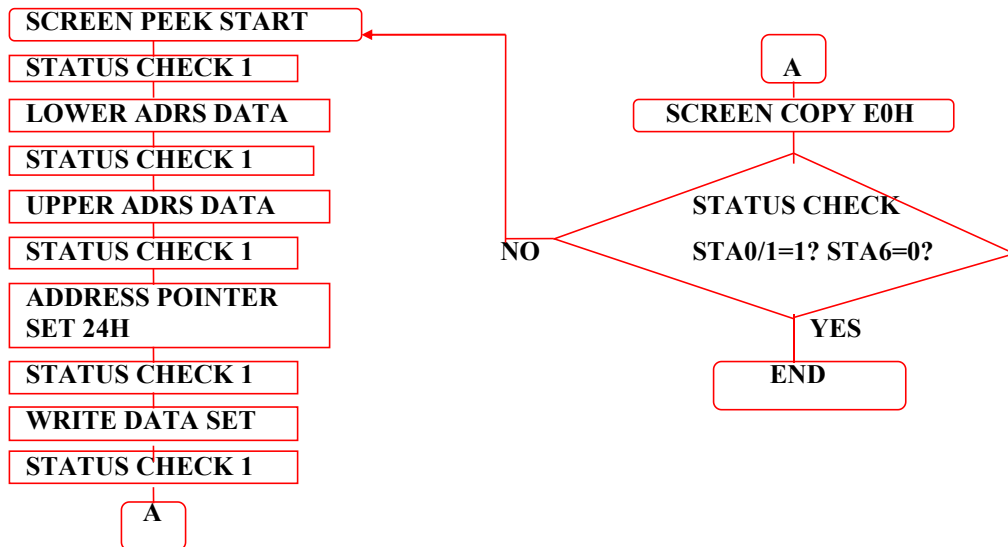

9.2.10 Bit set/reset

CODE	FUNCTION	CODE	FUNCTION
11110XXX	bit reset	1111X011	bit 3
11111XXX	bit set	1111X100	bit 4
1111X000	bit 0 (LSB)	1111X101	bit 5
1111X001	bit 1	1111X110	bit 6
1111X010	bit 2	1111X111	bit 7

This command is used to set or reset a bit of 1 byte is specified by address pointer. Plural bits in the 1 byte data cannot be set/reset at a time.

Refer following flow chart.

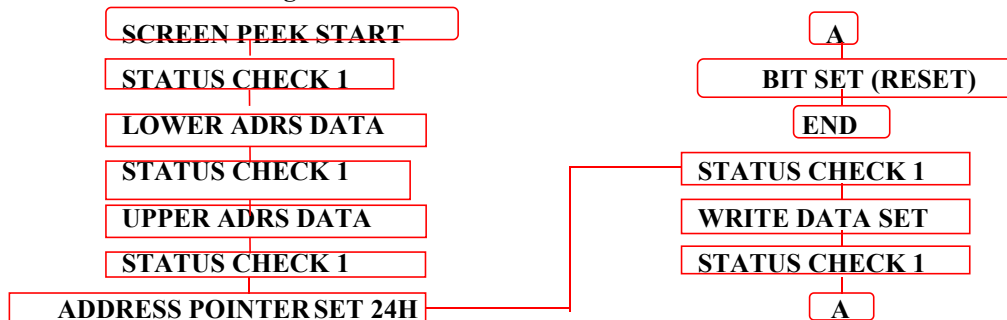

9.3 Flowchart of communications with MPU

9.3.1 Status Read

Before sending data (read/write), command it is necessary to check the status.

A) Status Check

Status of T6963C can be read from data lines.

RD = L, WR = H, CE = L, C/D = H, D0~7 -> Status word T6963C. Status word format is following.

MSB						LSB	
STA7	STA6	STA5	STA4	STA3	STA2	STA1	STA0
D7	D6	D5	D4	D3	D2	D1	D0
STA0	check capability of command execution				0: disable	1:enable	
STA1	check capability of data read/write				0: disable	1:enable	
STA2	check capability of auto mode data read				0: disable	1:enable	

STA3	check capability of auto mode data write	0: disable 1:enable
STA4	not use	
STA5	check capability of controller operation	0: disable 1:enable
STA6	error flag. using screen peek/copy command	0: no error
STA7	check the condition blink	0: display off 1:normal display

- Note:
1. It is necessary to check STA0 and STA1 at the same time. The error is happened by sending data at executing command.
 2. The status check will be enough to check STA0/STA1.
 3. The STA2/STA3 are valid in auto mode STA0/STA1 are invalid.

Status checking flow

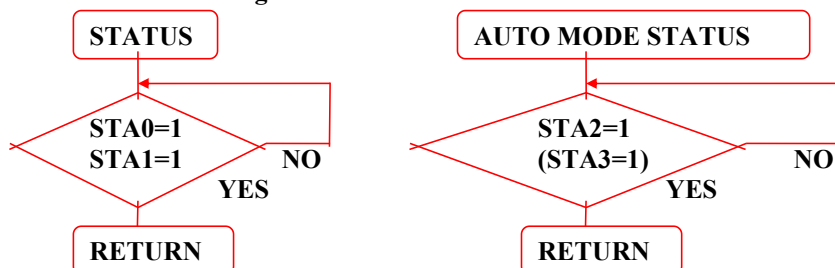

4. It is impossible to save status check in the case of command that is MSB 0. To have the delay time cannot be save status check. The interrupt of hardware is happened at the end of lines. If command of MSB0 is sent in this period, the command executing is waited. The state of waiting is not known without to check status. The sending next command or data is disregarded or rewrites data of waiting command

PAGE 13

9.3.2 Data Set

In T6963C, the data have been set and command executes.
The order of procedure of command sending

1) the case of 1 data

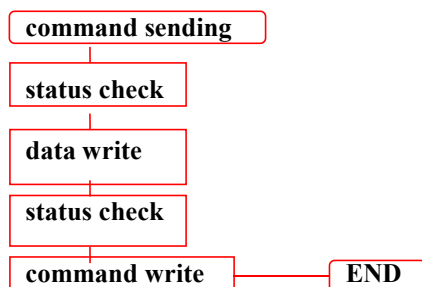

2) the case of 2 data

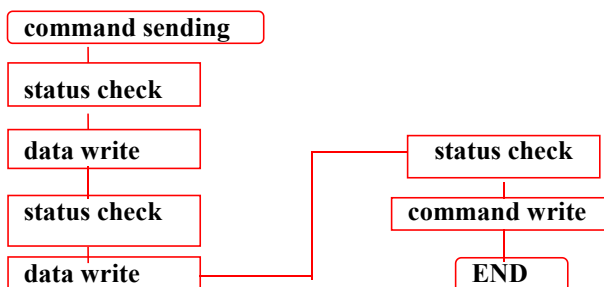

Note: In case of over 2 data sending, the last data (or last 2 data) is valid.

9.4 Initialize

Initialize of controller LSI T6963C is required for “Mode set”, “Control word set” after power on. Following is the one example of initialize procedure of 240x128 dots display (In case of 6x8 dots/font).

Command	C/D	D7 -----D0	Note
Power on		Power on	
Hard reset (use reset terminal)		RESET="L" (1msec minimum after VDD>4.75V)	
Mode set	1	1 0 0 0 0 0 0	“OR” mode
Control word set			
Graphic home position set (Graphic home position 000H)	0	0 0 0 0 0 0 0	graphic home address command
	0	0 0 0 0 0 0 0	
	1	0 1 0 0 0 0 1 0	
Number of graphic area set (Graphic 40x6 dots)	0	0 0 1 0 1 0 0 0	number of area command
	0	0 0 0 0 0 0 0 0	
	1	0 1 0 0 0 0 1 1	
Text home position set (Text home position 1000H)	0	0 0 0 0 0 0 0 0	text home address
	0	0 0 0 1 0 0 0 0	

	1	0 1 0 0 0 0 0	command
Number of text area set (text 40 column)	0	0 0 1 0 1 0 0	number of area
	0	0 0 0 0 0 0 0	
	1	0 1 0 0 0 0 1	command
Initialize end , Data Write			
Address pointer set (address pointer 0000H)	0	0 0 0 0 0 0 0	graphic home address
	0	0 0 0 0 0 0 0	
	1	0 0 1 0 0 1 0	command
Data Write (graphic)	0	0 1 0 1 0 1 0	Data
	1	1 1 1 0 0 0 0	command
	0	1 0 1 0 1 0 1	Data
	1	1 1 1 0 0 0 0	command
	x	x x x x x x x x	
Address pointer set (address pointer 1000H)	0	0 0 0 0 0 0 0	text home address
	0	0 0 0 1 0 0 0	
	1	0 0 1 0 0 1 0	command
Data write (text)	0	0 0 1 1 0 1 0	Data
	1	1 1 0 0 0 0 0	command
	0	0 0 1 0 1 1 1	Data
	1	1 1 0 0 0 0 0	command
	x	x x x x x x x x	
Display Mode Set (text/graphic on)	1	1 0 0 1 1 1 0 0	

Note 1: "status check" should be inserted between all command and data.

2 : Display mode set register is cleared (no display mode) by the hard reset , and no display is appeared on LCD panel. And just after "Display Mode set 9CH", written data is display on the LCD.

PAGE 14

10. RELIABILITY CONDITION

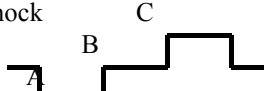
		TN Type		STN Type		
		Normal Temp.	Wide Temp.	Normal Temp.	Wide Temp.	
Viewing Angle	Horizontal Φ	$\pm 30^\circ$	$\pm 30^\circ$	$\pm 30^\circ$	$\pm 30^\circ$	
	Vertical Θ (mm)	10° to 30°	10° to 30°	-10° to 40°	-10° to 40°	
Operating Temperature		-10 to 70°C	-25 to 80°C	0 to 50°C	*-20 to 70°C	
Storage Temperature		-20 to 80°C	-35 to 90°C	-20 to 70°C	*-30 to 80°C	
High Temperature (Power Off)		240 Hours @70°C	240 Hours @90°C	240 Hours @65°C	240 Hours @75°C	
Low Temperature (Power Off)		240 Hours @-20°C	240 Hours @-35°C	240 Hours @-15°C	240 Hours @-25°C	
High Temperature (Power On)		240 Hours @70°C	240 Hours @80°C	240 Hours @60°C	240 Hours @70°C	
Low Temperature (Power On)		240 Hours @-10°C	240 Hours @-25°C	240 Hours @-10°C	240 Hours @-20°C	
High Temperature & High Humidity		55°C/90%RH 240 Hours	75°C/90%RH 240 Hours	45°C/90%RH 240 Hours	65°C/90%RH 240 Hours	
Thermal Shock 5 Cycle		A	60min@-20°C	60min@-35°C	60min@-20°C	60min@-30°C
		B	5min@25°C	5min@25°C	5min@25°C	5min@25°C
		C	60min@70°C	60min@90°C	60min@70°C	60min@80°C
Expected Lift		50,000 Hours	50,000 Hours	50,000 Hours	50,000 Hours	

*Wide temp. version may not available for some products, Please consult our sales engineer or representative.

11. FUNCTIONAL TEST & INSPECTION CRITERIA

11.1 Sample plan

Sample plan according to MIL-STD-105D level 2, and acceptance/rejection criteria is.

Base on : Major defect : AQL 0.65 Minor defect : AQL 2.5

11.2 Inspection condition

Viewing distance for cosmetic inspection is 30cm with bare eyes, and under an environment of 800 lus (20W)

light intensity. All direction for inspecting the sample should be within 45° against perpendicular line.

11.3 Definition of Inspection Zone in LCD

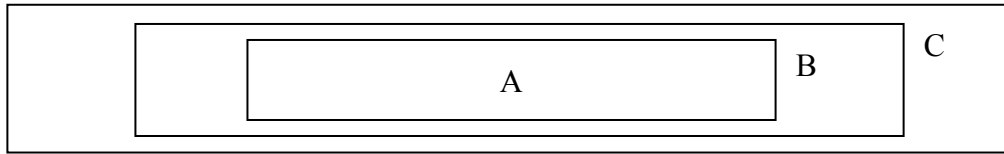

Zone A : Character / Digit area

Zone B : Viewing area except Zone A (Zone A + Zone B = minimum Viewing area)

Zone C : Outside viewing area (invisible area after assembly in customer’s product)

Note : As a general rule, visual defects in Zone C are permissible, when it is no trouble for quality and assembly of customer’s product.

11.4 Major Defect

All functional defects such as open (or missing segment), short, contrast differential, excess power consumption, smearing, leakage, etc. and overall outline dimension beyond the drawing. Are classified as major defects.

11.5 Minor Defect

Except the Major defects above, all cosmetic defects are classified as minor defects.

Item No	Item to be Inspected	Inspection Standard			Classification of defects		
1.	Spot defect (Defects in spot from)	Zone size (mm)	Acceptable Qty			Minor	
		$\Phi \leq 0.15$	A	B	C		
		$0.15 \leq \Phi \leq 0.20$	Acceptable (clustering of spot not allowed)				Acceptable
		$0.20 \leq \Phi \leq 0.25$	5	8			
		$\Phi > 0.25$	3	5			
			2	3			
Remarks : for dark/white spot, size Φ is defined as $\Phi = 1/2(X+Y)$							
2.	Line defect (Defects in line form)	Size (mm)		Acceptable Qty		Minor	
		L Length	W Width	Zone			
				A	B		C
		Acceptable	$W \leq 0.02$	Acceptable	Acceptable		
		$L \leq 3.0$	$W \leq 0.03$	2			
		$L > 2.5$	$W \leq 0.03$	0			
		$L \leq 3.0$	$0.03 < W \leq 0.05$	2			
		$L > 2.5$	$0.03 < W \leq 0.05$	0			
			$W > 0.05$	Counted as spot defect (Follows item 11.5.1)			
Remarks: The total of spot defect and line defect shall not exceed four.							

3.	Orientation defect (such as misalignment of L/C)	Not allowed inside viewing area (Zone A or Zone B)	Minor		
4.	Polarizing	11.5.4.1 Polarizer Position 1.Shifting in Position Should not exceed the glass outline dimension. 2.Incomplete covering of the viewing area due to shifting isn't allowed	Minor		
		11.5.4.2 Seratches, bubble or dent on Glass/Polarizer/Reflector, Bubble between Polarizer & Reflector/Glass:			
		Size (mm)		Acceptable Qty	
				Zone	
				A B C	
		$\Phi \leq 0.20$		Acceptable	Acceptable
		$0.20 < \Phi \leq 0.50$		3	
$0.50 < \Phi \leq 1.00$	2				
$\Phi > 1.00$	0				

12. CG ROM PATTERN

LSB MSB	0	1	2	3	4	5	6	7	8	9	A	B	C	D	E	F
0	!	"	#	\$	%	&	'	()	*	+	,	-	.	/	
1	0	1	2	3	4	5	6	7	8	9	:	;	<	=	>	?
2	a	b	c	d	e	f	g	h	i	j	k	l	m	n	o	
3	p	q	r	s	t	u	v	w	x	y	z	[\]	^	_
4	~	`	a	b	c	d	e	f	g	h	i	j	k	l	m	n
5	p	q	r	s	t	u	v	w	x	y	z	{		}	~	
6	ª	º	º	º	º	º	º	º	º	º	º	º	º	º	º	º
7	º	º	º	º	º	º	º	º	º	º	º	º	º	º	º	º